

PRADEEP KUMAR DHAL SAMANT

4TH SEM

ANALOGI ETC

&

OP-AMP .

PHD

lect in ETC

CHAPTER - 1

[P-N JUNCTION DIODE]

❖ DEFINITION:-

- When a p-type semiconductor is suitably joined to n-type semiconductor, the contact surface is called **p-n Junction**.

❖ FORMATION OF PN JUNCTION

- In actual practice, the characteristic properties of PN junction will not be apparent if a p-type block is just brought in contact with n-type block.
- It is fabricated by special techniques and one common method of making PN junction is called **Alloying**.

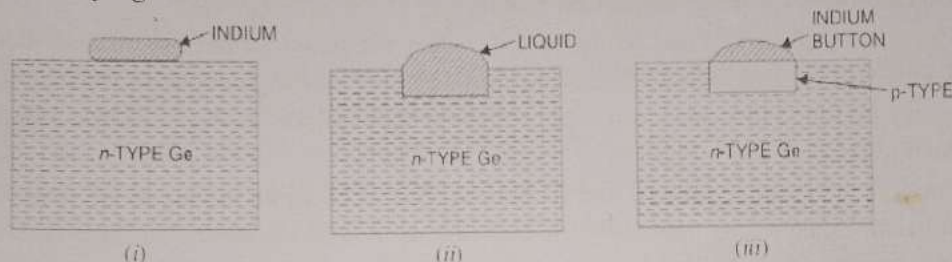

[Figures of different stages of formation of PN junction by Alloying method]

- In this method, a small block of indium (trivalent impurity) is placed on an n-type germanium slab as shown in Fig (i). The system is then heated to a temperature of about 500°C. The indium and some of the germanium melt to form a small puddle of molten germanium-indium mixture as shown in Fig (ii). The temperature is then lowered and puddle begins to solidify.
- Under proper conditions, the atoms of indium impurity will be suitably adjusted in the germanium slab to form a single crystal.
- The addition of indium overcomes the excess of electrons in the n-type germanium to such an extent that it creates a p-type region.
- As the process goes on, the remaining molten mixture becomes increasingly rich in indium. When all germanium has been re-deposited, the remaining material appears as indium button which is frozen on to the outer surface of the crystallized portion as shown in Fig (iii).

❖ PROPERTIES OF PN JUNCTION

- To explain PN junction, consider two types of materials: -
 - 1) P-Type - P-type semiconductor having -ive acceptor ions and +ive charged holes.
 - 2) N-Type - N-type semiconductor having +ive donor ions and -ive free electrons.
- P-type has high concentration of holes & N-type has high concentration of electrons.
- The tendency for the free electron to diffuse over p-side and holes to n-side process is called **Diffusion**.

- When a free electron move across the junction from n-type to p-type, positive donor ions are removed by the force of electrons. Hence positive charge is built on the n-side of the junction. Similarly negative charge establish on p-side of the junction.
- When sufficient no of donor and acceptor ions gathered at the junction, further diffusion is prevented.
- Since +ive charge on n-side repel holes to cross from p-side to n-side, similarly -ive charge on p-side repel free electrons to cross from n-type to p-type.
- Thus a barrier is set up against further movement of charge carriers is hole or electrons.
- This barrier is called as **Potential Barrier/ Junction Barrier (V_0)** and is of the order 0.1 to 0.3 volt. This prevents the respective majority carriers for crossing the barrier region. This region is known as **Depletion Layer**.
- The term depletion is due to the fact that near the junction, the region is depleted (i.e. emptied) of charge carries (free electrons and holes) due to diffusion across the junction. It may be noted that depletion layer is formed very quickly and is very thin compared to the n region and the p-region.
- Once pn junction is formed and depletion layer created, the diffusion of free electrons stops. In other words, the depletion region acts as a barrier to the further movement of free electrons across the junction.
- The positive and negative charges set up an electric field as shown in fig below.

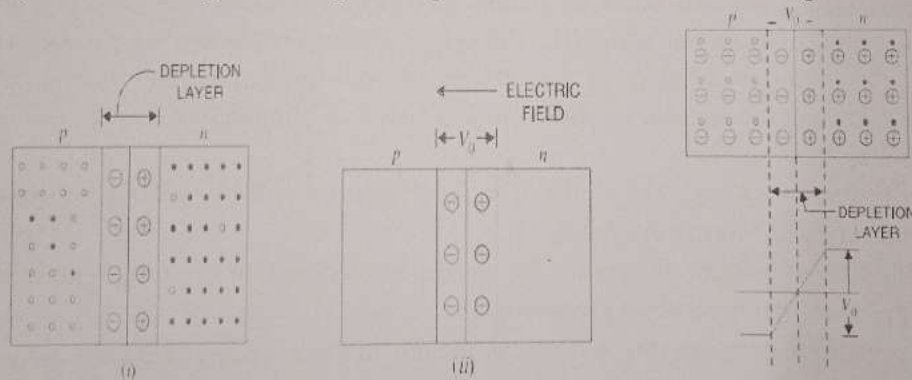

- The electric field is a barrier to the free electrons in the n-region.
- There exists a potential difference across the depletion layer and is called barrier potential (V_0). The barrier potential of a p-n junction depends upon several factors including the type of semiconductor material, the amount of doping and temperature.
- The typical barrier potential is approximately: - For Si, $V_0 = 0.7$ V, For Ge, $V_0 = 0.3$ V.

❖ PN JUNCTION UNDER FORWARD BIASING

- When external D.C. voltage applied to the junction is in such a direction that it cancels the potential barrier, thus permitting current flow, it is called Forward Biasing.
- To apply forward bias, connect positive terminal of the battery to p-type and negative terminal to n-type as shown in fig below.

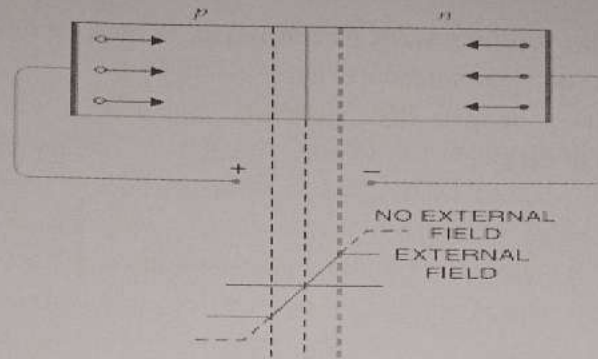

- The applied forward potential establishes an electric field which acts against the field due to potential barrier. Therefore, the resultant field is weakened and the barrier height is reduced at the junction.
- As potential barrier voltage is very small (0.1 to 0.3 V), therefore, a small forward voltage is sufficient to completely eliminate the barrier.
- Once the potential barrier is eliminated by the forward voltage, junction resistance becomes almost zero and a low resistance path is established for the entire circuit.
- Therefore, current flows in the circuit. This is called Forward Current.
- With forward bias to PN junction, the following points are worth noting :
 - (i) The potential barrier is reduced and at some forward voltage (0.1 to 0.3 V), it is eliminated altogether.
 - (ii) The junction offers low resistance (called forward resistance, R_f) to current flow.
 - (iii) Current flows in the circuit due to the establishment of low resistance path. The magnitude of current depends upon the applied forward voltage.

❖ CURRENT FLOW IN A FORWARD BIASED PN JUNCTION:-

- It is concluded that in n-type region, current is carried by free electrons whereas in p-type region, it is carried by holes. However, in the external connecting wires, the current is carried by free electrons.

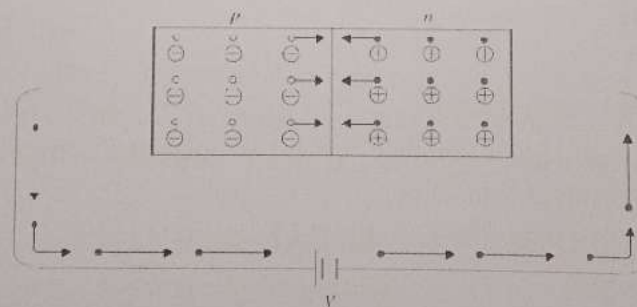

❖ PN JUNCTION UNDER REVERSE BIASING

- When the external D.C. voltage applied to the junction is in such a direction that potential barrier is increased, it is called **Reverse Biasing**.
- To apply reverse bias, connect negative terminal of the battery to p-type and positive terminal to n-type.

- It is clear that applied reverse voltage establishes an electric field which acts in the same direction as the field due to potential barrier.
- Therefore, the resultant field at the junction is strengthened and the barrier height is increased as shown in fig below .

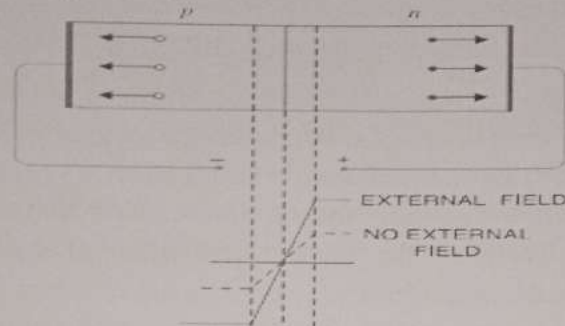

- The increased potential barrier prevents the flow of charge carriers across the junction.
- Thus, a high resistance path is established for the entire circuit and hence the current does not flow.
- With reverse bias to PN junction, the following points are worth noting:
 - (i) The potential barrier is increased.
 - (ii) The junction offers very high resistance (Reverse Resistance R_r) to current flow.
 - (iii) No current flows in the circuit due to the establishment of high resistance path.

❖ VOLT-AMPERE CHARACTERISTICS OF PN JUNCTION:-

- Volt-ampere or V-I characteristic of a pn junction (also called a crystal or semiconductor diode) is the curve between voltage across the junction and the circuit current.
- Usually, voltage is taken along x-axis and current along y-axis. Fig. shows the circuit arrangement for determining the V-I characteristics of a pn junction.
- The characteristics can be studied under three heads namely:
 - 1) Zero external voltage
 - 2) Forward Bias
 - 3) Reverse Bias.

❖ ZERO EXTERNAL VOLTAGE: -

- When the external voltage is zero, i.e. circuit is open at K; the potential barrier at the junction does not permit current flow.

Therefore, the circuit current is zero as indicated by point O in Fig.

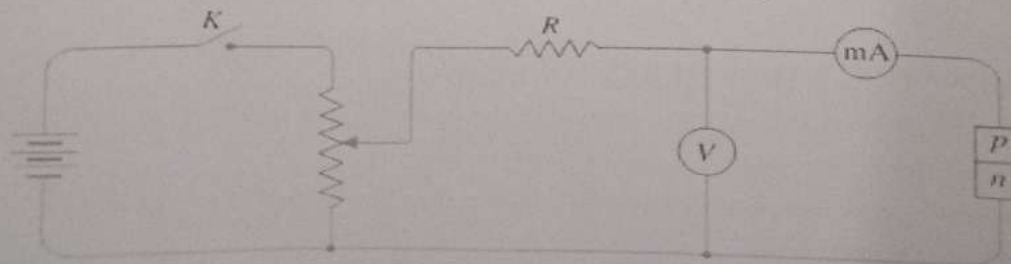

(II) FORWARD BIAS: -

- With forward bias to the pn junction i.e. p-type connected to positive terminal and n-type connected to negative terminal, the potential barrier is reduced.
- At some forward voltage (0.7 V for Si and 0.3 V for Ge), the potential barrier is altogether eliminated and current starts flowing in the circuit.
- From now onwards, the current increases with the increase in forward voltage.
- Thus, a rising curve OB is obtained with forward bias as shown in Fig. From the forward characteristic, it is seen that at first (region OA), the current increases very slowly and the curve is non-linear.
- It is because the external applied voltage is used up in overcoming the potential barrier.
- However, once the external voltage exceeds the potential barrier voltage, the pn junction behaves like an ordinary conductor.
- Therefore, the current rises very sharply with increase in external voltage (region AB on the curve). Here the curve is almost linear.

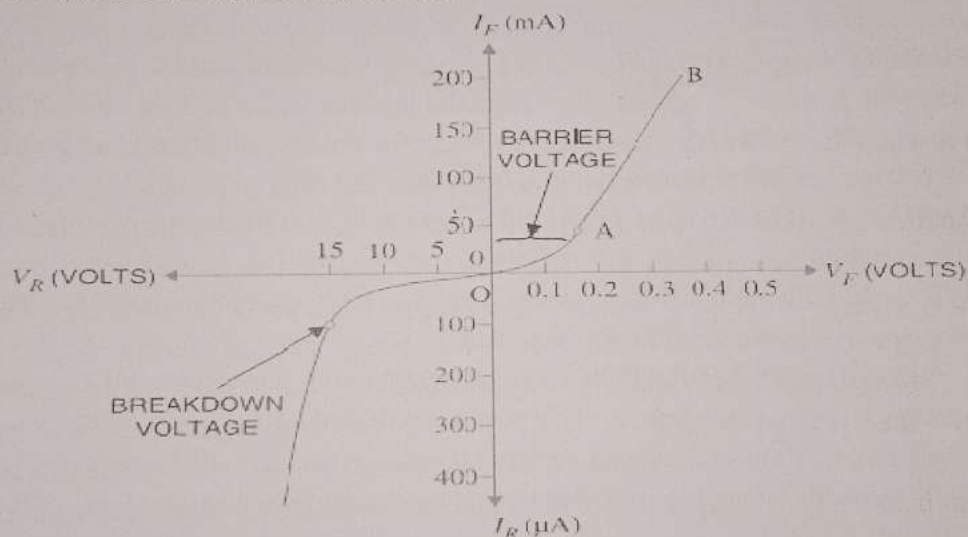
**(III) REVERSE BIAS:-**

- With reverse bias to the pn junction i.e. p-type connected to negative terminal and n-type connected to positive terminal, potential barrier at the junction is increased.
- Therefore, the junction resistance becomes very high and practically no current flows through the circuit.
- However, in practice, a very small current (of the order of μA) flows in the circuit with reverse bias as shown in the reverse characteristic.
- This is called Reverse Saturation Current (I_s) and is due to the minority carriers.
- It may be recalled that there are a few free electrons in p-type material and a few holes in n-type material.
- These undesirable free electrons in p-type and holes in n-type are called minority carriers. Therefore, a small current flows in the reverse direction.

- If reverse voltage is increased continuously, the kinetic energy of electrons (minority carriers) may become high enough to knock out electrons from the semiconductor atoms.
- At this stage breakdown of the junction occurs, characterized by a sudden rise of reverse current and a sudden fall of the resistance of barrier region. This may destroy the junction permanently.
- **Note:** -The forward current through a p-n junction is due to the majority carriers produced by the impurity.
- However, reverse current is due to the minority carriers produced due to breaking of some covalent bonds at room temperature.

❖ **IMPORTANT TERMS:** -

(i)**BREAKDOWN VOLTAGE:** - It is the minimum reverse voltage at which pn junction breaks down with sudden rise in reverse current.

(ii)**KNEE VOLTAGE:** - It is the forward voltage at which the current through the junction starts to increase rapidly.

(iii) **PEAK INVERSE VOLTAGE (PIV):**- It is the maximum reverse voltage that can be applied to the pn junction without damage to the junction. If the reverse voltage across the junction exceeds its PIV, the junction may be destroyed due to excessive heat. The peak inverse voltage is of particular importance in rectifier service.

(iv)**MAXIMUM FORWARD CURRENT:**- It is the highest instantaneous forward current that a pn junction can conduct without damage to the junction. Manufacturer's data sheet usually specifies this rating. If the forward current in a pn junction is more than this rating, the junction will be destroyed due to overheating.

(v) **MAXIMUM POWER RATING:** - It is the maximum power that can be dissipated at the junction without damaging it. The power dissipated at the junction is equal to the product of junction current and the voltage across the junction. This is a very important consideration and is invariably specified by the manufacturer in the data sheet.

❖ **DC LOAD LINE:-**

- The line obtained by joining the maximum values of I_c and V_{cc} in the output characteristics of a CE configuration transistor is known as the DC Load Line.

❖ **PN JUNCTION BREAKDOWN:-**

- Electrical break down of semiconductor can occur due to two different phenomena. Those two phenomena are

1. Zener breakdown
2. Avalanche breakdown

❖ **ZENER BREAKDOWN:-**

- A properly doped crystal diode which has a sharp breakdown voltage is known as a **Zener Diode**.

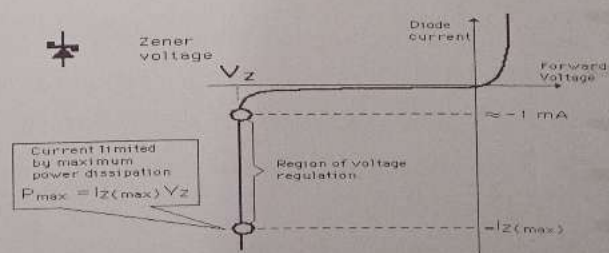

- It has already been discussed that when the reverse bias on a crystal diode is increased, a critical voltage, called Breakdown Voltage is reached where the reverse current increases sharply to a high value.
- The breakdown region is the knee of the reverse characteristic as shown in Figure.
- The satisfactory explanation of this breakdown of the junction was first given by the American scientist C. Zener.
- The breakdown voltage is sometimes called Zener Voltage and the sudden increase in current is known as Zener Current. The breakdown or Zener voltage depends upon the amount of doping. If the diode is heavily doped, depletion layer will be thin and consequently the breakdown of the junction will occur at a lower reverse voltage.
- On the other hand, a lightly doped diode has a higher breakdown voltage. Fig. shows the symbol of a Zener diode. It may be seen that it is just like an ordinary diode except that the bar is turned into z-shape.



❖ PROPERTIES OF ZENER DIODE:-

- The following points may be noted about the Zener diode:
- A Zener diode is like an ordinary diode except that it is properly doped to have a sharp breakdown voltage. A Zener diode is always reverse connected i.e. it is always reverse biased. A Zener diode has sharp breakdown voltage, called Zener voltage V_Z .
- When forward biased, its characteristics are just those of ordinary diode.
- The Zener diode is not immediately burnt just because it has entered the breakdown region. As long as the external circuit connected to the diode limits the diode current to less than burn out value, the diode will not burn out.
- Zener diode operated in this region will have a relatively constant voltage across it, regardless of the value of current through the device. This permits the Zener diode to be used as a **Voltage Regulator**.

➤ WORKING/OPERATION OF ZENER BREAKDOWN:-

- When the reverse voltage across the pn junction diode increases, the electric field across the diode junction increases (both internal & external).
- This results in a force of attraction on the negatively charged electrons at junction.
- This force frees electrons from its covalent bond and moves those free electrons to conduction band. When the electric field increases (with applied voltage), more and more electrons are freed from its covalent bonds.
- This results in drifting of electrons across the junction and electron hole recombination occurs. So a net current is developed and it increases rapidly with increase in electric field. Zener breakdown phenomena occurs in a pn junction diode with heavy doping & thin junction (means depletion layer width is very small).
- Zener breakdown does not result in damage of diode since current is only due to drifting of electrons, there is a limit to the increase in current as well.

➤ AVALANCHE BREAKDOWN:-

- Avalanche breakdown occurs in a p-n junction diode which is moderately doped and has a thick junction (means its depletion layer width is high).
- Avalanche breakdown usually occurs when we apply a high reverse voltage across the diode (obviously higher than the zener breakdown voltage, say V_z).
- By increasing the applied reverse voltage, the electric field across junction will keep increasing. If applied reverse voltage is V_a and the depletion layer width is d , then the generated electric field can be calculated as $E_a = V_a/d$.
- This generated electric field exerts a force on the electrons at junction and it frees them from covalent bonds. These free electrons will gain acceleration and it will start moving across the junction with high velocity.
- This results in collision with other neighboring atoms. These collisions in high velocity will generate further free electrons. These electrons will start drifting and electron-hole pair recombination occurs across the junction. This results in net current which rapidly increases.

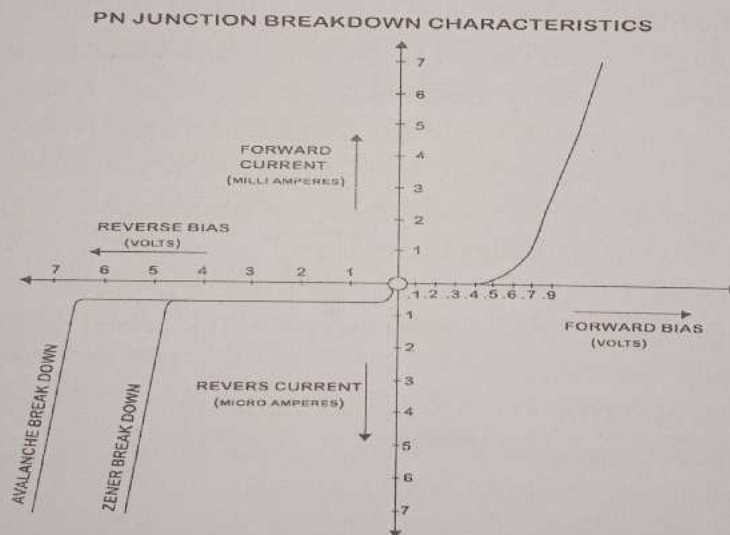

- From the above fig we can see that avalanche breakdown occurs at a voltage (V_a) which is higher than zener breakdown voltage (V_z).
- It is because avalanche phenomena occurs in a diode which is moderately doped and junction width (say d) is high where as zener break down occurs in a diode with heavy doping and thin junction (here d is small).
- The electric field that occur due to applied reverse voltage (say V) can be calculated as $E = V/d$. So in a Zener breakdown, the electric field necessary to break electrons from covalent bond is achieved with lesser voltage than in avalanche breakdown due to thin depletion layer width.

- In avalanche breakdown, the depletion layer width is higher and hence much more reverse voltage has to be applied to develop the same electric field strength (necessary enough to break electrons free).

➤ CLIPPING CIRCUITS

- The circuit with which the waveform is shaped by removing (or clipping) a portion of the applied wave is known as a clipping circuit.
- Clippers find extensive use in radar, digital and other electronic systems.
- Although several clipping circuits have been developed to change the wave shape, we concentrate only on diode clippers.
- These clippers can remove signal voltages above or below a specified level.
- The important diode clippers are:-
 1. Positive clipper and negative clipper
 2. Biased positive clipper and biased negative clipper
 3. Combination clipper.

➤ POSITIVE CLIPPER

- A positive clipper is that which removes the positive half-cycles of the input voltage.
- The positive clipper is of two types
 1. Positive series clipper
 2. Positive shunt clipper
- The below Fig. shows the typical circuit of a positive shunt clipper using a diode.

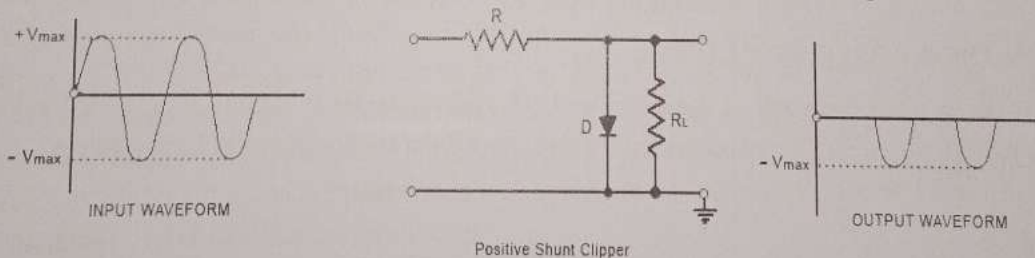

- Here the diode is kept in parallel with the load.
- During the positive half cycle, the diode 'D' is forward biased and the diode acts as a closed switch. This causes the diode to conduct heavily.
- This causes the voltage drop across the diode or across the load resistance R_L to be zero. Thus output voltage during the positive half cycles is zero.
- During the negative half cycles of the input signal voltage, the diode D is reverse biased and behaves as an open switch. Consequently the entire input voltage appears across the diode or across the load resistance R_L if R is much smaller than R_L .
- Actually the circuit behaves as a voltage divider with an output voltage of $-\frac{R_L}{R+R_L}$
 $V_{\max} \cong -V_{\max}$ (Taking or assuming when $R_L \gg R$).

➤ **NEGATIVE CLIPPER**

➤ A negative clipper is that which removes the positive half-cycles of the input voltage. The negative clipper is of two types

1. Negative series clipper
2. Negative shunt clipper

➤ The below Fig. shows the typical circuit of a negative shunt clipper using a diode.

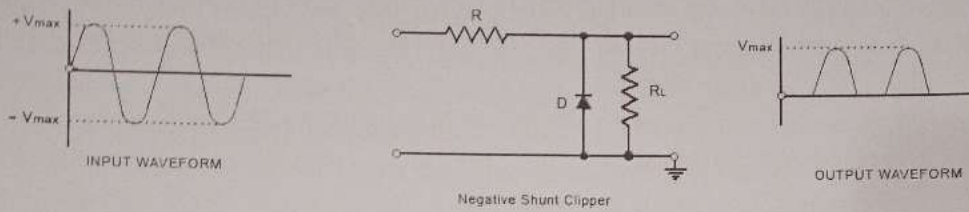

- During the negative half cycle, the diode 'D' is forward biased and the diode acts as a closed switch. This causes the diode to conduct heavily.
- This causes the voltage drop across the diode or across the load resistance R_L to be zero. Thus output voltage during the negative half cycles is zero.
- During the positive half cycles of the input signal voltage, the diode D is reverse biased and behaves as an open switch. Consequently the entire input voltage appears across the diode or across the load resistance R_L if R is much smaller than R_L .
- Actually the circuit behaves as a voltage divider with an output voltage of $\left[\frac{R_L}{R + R_L} \right]$
 $V_{max} \cong V_{max}$ (Taking or assuming when $R_L \gg R$).

➤ **BIASED POSITIVE CLIPPER**

➤ When a small portion of the positive half cycle is to be removed, it is called a biased positive clipper. The circuit diagram and waveform is shown in the figure below.

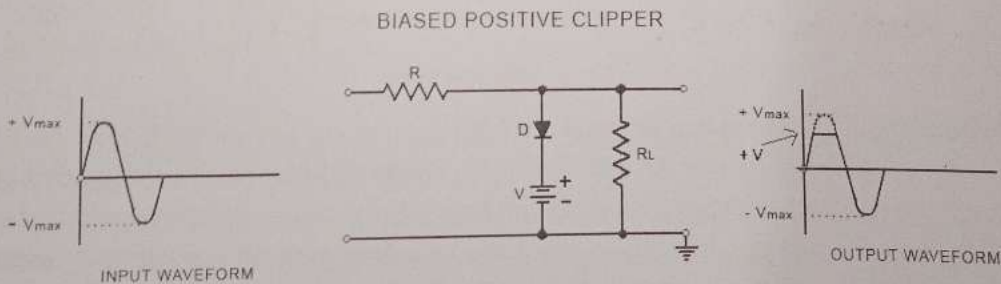

- During negative half cycle, when the input signal voltage is negative, the diode 'D' is reverse-biased. This causes it to act as an open-switch. Thus the entire negative half cycle appears across the load, as illustrated by output waveform.
- During positive half cycle, when the input signal voltage is positive but does not exceed battery the voltage 'V', the diode 'D' remains reverse-biased and most of the input voltage appears across the output.

- When during the positive half cycle of input signal, the signal voltage becomes more than the battery voltage V , the diode D is forward biased and so conducts heavily. The output voltage is equal to $+V$ and stays at $+V$ as long as the magnitude of the input signal voltage is greater than the magnitude of the battery voltage, V .
- Thus a biased positive clipper removes input voltage when the input signal voltage becomes greater than the battery voltage.

➤ **BIASED NEGATIVE CLIPPER**

- When a small portion of the negative half cycle is to be removed, it is called a biased negative clipper. The circuit diagram and waveform is shown in the figure below.

BIASED NEGATIVE CLIPPER

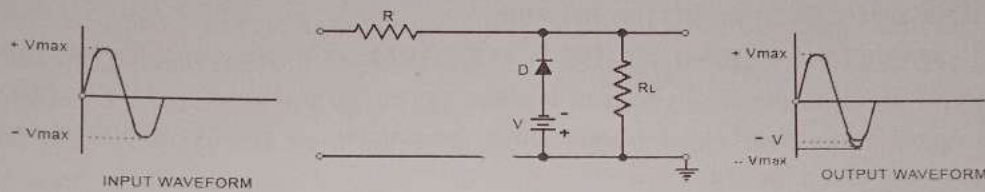

- During positive half cycle, when the input signal voltage is positive, the diode D is reverse-biased. This causes it to act as an open-switch. Thus the entire positive half cycle appears across the load, as illustrated by output waveform.
- During negative half cycle, when the input signal voltage is negative but does not exceed battery the voltage V , the diode D remains reverse-biased and most of the input voltage appears across the output.
- When during the negative half cycle of input signal, the signal voltage becomes more than the battery voltage V , the diode D is forward biased and so conducts heavily. The output voltage is equal to $-V$ and stays at $-V$ as long as the magnitude of the input signal voltage is greater than the magnitude of the battery voltage, V .
- Thus a biased negative clipper removes input voltage when the input signal voltage becomes greater than the battery voltage.

➤ **COMBINATION CLIPPER:-**

- Combination clipper is employed when a portion of both positive and negative of each half cycle of the input voltage is to be clipped (or removed) using a biased positive and negative clipper together. The circuit for such a clipper is given in the figure below.

COMBINATION CLIPPER

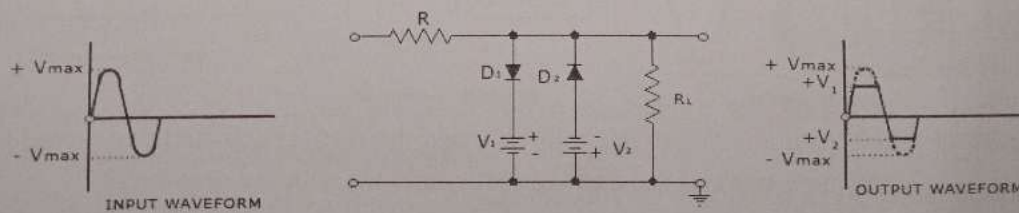

- For positive input voltage signal when input voltage exceeds battery voltage $+V_1$ diode D_1 conducts heavily while diode D_2 is reverse biased and so voltage $+V_1$ appears across the output. This output voltage $+V_1$ stays as long as input signal voltage exceeds $+V_1$.
- On the other hand for the negative input voltage signal, the diode D_1 remains reverse biased and diode D_2 conducts heavily only when input voltage exceeds battery voltage V_2 in magnitude.
- Thus during the negative half cycle the output stays at $-V_2$ so long as the input signal voltage is greater than $-V_2$.
- **APPLICATIONS OF CLIPPER:-**
- There are numerous clipper applications however, in general, clippers are used to perform one of the following two functions:

(i) **CHANGING THE SHAPE OF WAVEFORM:-** Clippers can alter the shape of a waveform. For example, a clipper can be used to convert a sine wave into a rectangular wave, square wave etc. They can limit either the negative or positive alternation or both alternations of an a.c. voltage.

(ii) **CIRCUIT TRANSIENT PROTECTION:-** Transients can cause considerable damage to many types of circuits e.g., a digital circuit. In that case, a clipper diode can be used to prevent the transient from reaching that circuit.

➤ CLAMPER CIRCUITS:-

- A clamping circuit is used to place either the positive or negative peak of a signal at a desired level. The dc component is simply added or subtracted to/from the input signal.
- The clamper is also referred to as an IC restorer and ac signal level shifter.
- A clamp circuit adds the positive or negative dc component to the input signal so as to push it either on the positive side.
- The clamper is of two types :-
 1. Positive clamper
 2. Negative clamper
- The circuit will be called a positive clamper, when the signal is pushed upward side by the circuit and the negative peak of the signal coincides with the zero level.

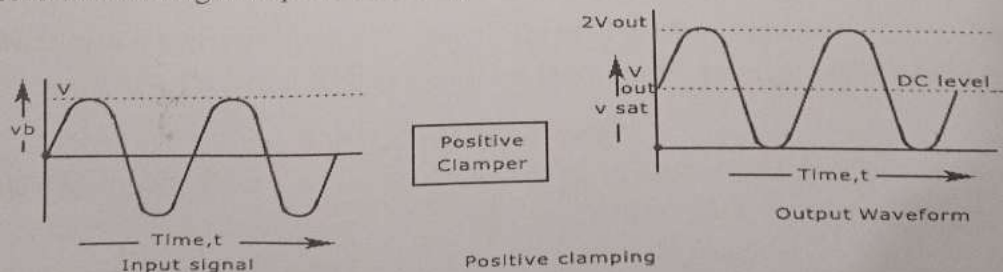

- The circuit will be called a negative clamper, when the signal is pushed downward by the circuit and the positive peak of the input signal coincides with the zero level.

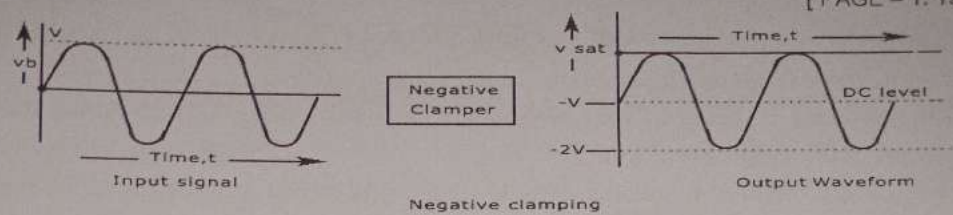

Negative clamping

- For a clamping circuit at least three components — a diode, a capacitor and a resistor are required. Sometimes an independent dc supply is also required to cause an additional shift. The important points regarding clamping circuits are:
 1. The shape of the waveform will be the same, but its level is shifted either upward or downward.
 2. There will be no change in the peak-to-peak or r.m.s value of the waveform due to the clamping circuit. Thus, the input waveform and output waveform will have the same peak-to-peak value that is, $2V_{max}$. This is shown in the figure above. It must also be noted that same readings will be obtained in the ac voltmeter for the input voltage and the clamped output voltage.
 3. There will be a change in the peak and average values of the waveform. In the figure shown above, the input waveform has a peak value of V_{max} and average value over a complete cycle is zero. The clamped output varies from $2V_{max}$ and 0 (or 0 and $-2V_{max}$). Thus the peak value of the clamped output is $2V_{max}$ and average value is V_{max} .
 4. The values of the resistor R and capacitor C affect the waveform.
 5. The values for the resistor R and capacitor C should be determined from the time constant equation of the circuit, $t = RC$. The values must be large enough to make sure that the voltage across capacitor C does not change significantly during the time interval the diode is non-conducting. In a good clamper circuit, the circuit time constant $t = RC$ should be at least ten times the time period of the input signal voltage. It is advantageous to first consider the condition under which the diode becomes forward biased.

❖ **POSITIVE CLAMPER:-**

➤ Consider a ~~negative~~ ^{positive} clamping circuit, a circuit that shifts the original signal in a vertical ~~upward~~ ^{downward} direction.

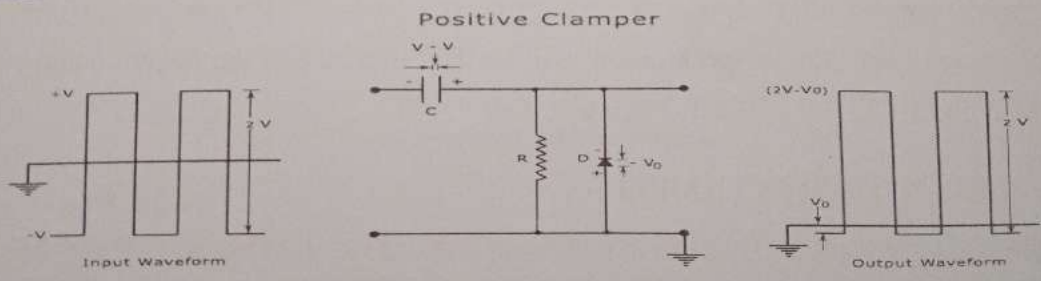

- The diode D will be forward biased and the capacitor C is charged with the polarity shown, when an input signal is applied.
- During the negative half cycle of input, the output voltage will be equal to the barrier potential of the diode, V_0 and capacitor is charged to $(V - V_0)$.

- During the positive half cycle, the diode becomes reverse-biased and acts as an open-circuit. Thus, there will be no effect on the capacitor voltage.
- The resistance R , being of very high value, cannot discharge C a lot during the positive portion of the input waveform.
- Thus during positive input, the output voltage will be the sum of the input voltage and capacitor voltage $= +V + (V - V_0) = +(2V - V_0)$.
- The value of the peak-to-peak output will be the difference of the negative and positive peak voltage levels is equal to $(2V - V_0) - V_0 = 2V$.

❖ NEGATIVE CLAMPER:-

- Consider a negative clamping circuit, a circuit that shifts the original signal in a vertical downward direction.

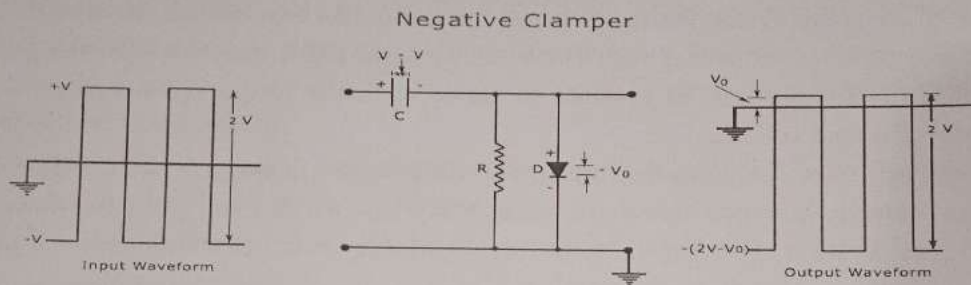

- The diode D will be forward biased and the capacitor C is charged with the polarity shown, when an input signal is applied.
- During the positive half cycle of input, the output voltage will be equal to the barrier potential of the diode, V_0 and capacitor is charged to $(V - V_0)$.
- During the negative half cycle, the diode becomes reverse-biased and acts as an open-circuit. Thus, there will be no effect on the capacitor voltage.
- The resistance R , being of very high value, cannot discharge C a lot during the negative portion of the input waveform.
- Thus during negative input, the output voltage will be the sum of the input voltage and capacitor voltage $= -V - (V - V_0) = -(2V - V_0)$.
- The value of the peak-to-peak output will be the difference of the negative and positive peak voltage levels is equal to $V_0 - [-(2V - V_0)] = 2V$.

❖ APPLICATIONS OF CLAMPER:-

- Clamping circuits are often used in television receivers as dc restorers in the TV receiver. They also find applications in storage counters, analog frequency meter, capacitance meter, divider and stair-case waveform generator.

CHAPTER - 2

[SPECIAL SEMICONDUCTOR DEVICES]

❖ THERMISTOR

- Thermistor is the contraction of the term Thermal Resistor.
- It is generally composed of semiconductor materials. Most thermistors have a negative coefficient of temperature that is their resistance decreases with the increases of temperature.
- This high sensitivity to temperature changes makes thermistors extremely useful for precision temperature measurement, control and compensation.
- The temperature measurement of thermistor ranges from $-60\text{ }^{\circ}\text{C}$ to $150\text{ }^{\circ}\text{C}$ and the resistance of thermistor ranges from 0.5Ω to $0.75\text{M}\Omega$. It exhibits highly non-linear characteristics of resistance versus temperature.

❖ CONSTRUCTION

- These thermistors are composed of sintered mixture of metallic oxides such as Manganese, Nickel, Cobalt, Copper, Iron and Uranium.
- These may be in the form of beads or rods or discs or probes.
- The relation between resistance and absolute temperature of a thermistor can be represented as

- $R_{T_1} = R_{T_2} \exp[\beta(1/T_1) - (1/T_2)]$
- Where R_{T_1} = resistance of thermistor at absolute temperature T_1 K
- R_{T_2} = resistance of thermistor at absolute temperature T_2 K
- And β = a constant depending on the material of the thermistor (usually it ranges from 3500 K to 4500 K).

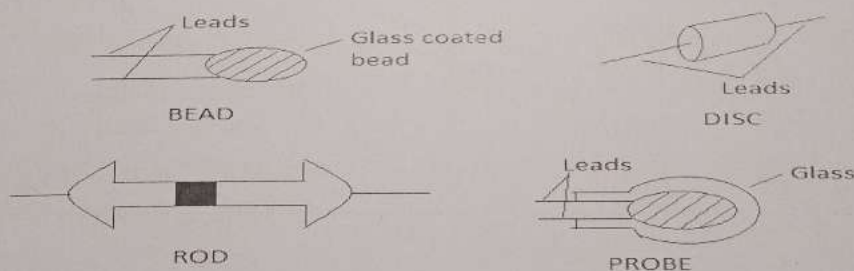

[Different Types Of Thermistors]

❖ FEATURES

- These are compact, rugged and inexpensive and have good stability when properly aged.
- Measuring current is maintained at a value as low as possible. so that self-heating of thermistors is avoided otherwise errors are introduced on account of changes of resistance caused by self-heating.

CHAPTER - 2

----- [SPECIAL SEMICONDUCTOR DEVICES] -----

❖ THERMISTOR

- Thermistor is the contraction of the term Thermal Resistor.
- It is generally composed of semiconductor materials. Most thermistors have a negative coefficient of temperature that is their resistance decreases with the increases of temperature.
- This high sensitivity to temperature changes makes thermistors extremely useful for precision temperature measurement, control and compensation.
- The temperature measurement of thermistor ranges from -60°C to 150°C and the resistance of thermistor ranges from 0.5Ω to $0.75\text{M}\Omega$. It exhibits highly non-linear characteristics of resistance versus temperature.

❖ CONSTRUCTION

- These thermistors are composed of sintered mixture of metallic oxides such as Manganese, Nickel, Cobalt, Copper, Iron and Uranium.
- These may be in the form of beads or rods or discs or probes.
- The relation between resistance and absolute temperature of a thermistor can be represented as

- $R_{T1} = R_{T2} \exp[\beta(1/T1) - (1/T2)]$
- Where R_{T1} = resistance of thermistor at absolute temperature $T1$ K
- R_{T2} = resistance of thermistor at absolute temperature $T2$ K
- And β = a constant depending on the material of the thermistor (usually it ranges from 3500 K to 4500 K).

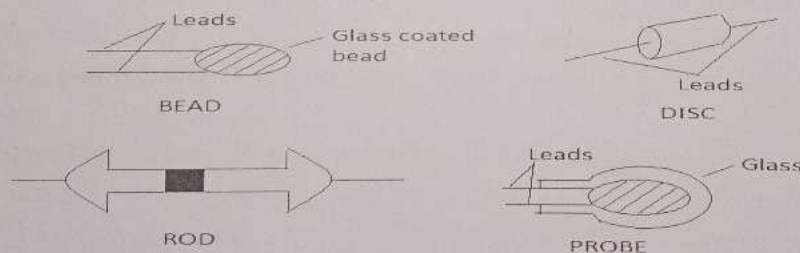

[Different Types Of Thermistors]

❖ FEATURES

- These are compact, rugged and inexpensive and have good stability when properly aged.
- Measuring current is maintained at a value as low as possible so that self-heating of thermistors is avoided otherwise errors are introduced on account of changes of resistance caused by self-heating.

- The upper operating limit of temperature for thermistor is dependent on physical changes in the material.
- For thermistor the Response time can vary from fraction of second to minute depending on the size of detecting mass and thermal capacity of the thermistor.
- Response time varies inversely with dissipation factor.

❖ **APPLICATIONS**

- It is used for measurement and control of temperature and for temperature compensation.
- It is used for measurement of power at high frequency. It is also used for thermal conductivity.
- Thermistor is used for measurement of level, flow and pressure of liquid, composition of gases and vacuum measurement. It is used for providing time delay.

❖ **BARRETERS**

- Barreters are the short length wires with fine diameters with operating range around 1500C.

❖ **SENSORS**

- A **sensor** is a device that detects events or changes in quantities and provides a corresponding output, generally as an electrical or optical signal; for example, a thermocouple converts temperature to an output voltage.
- Sensors are used in everyday objects such as touch-sensitive elevator buttons and lamps which dim or brighten by touching the base, besides innumerable applications of which most people are never aware.
- With advances in micro machinery and easy to use microcontroller platforms, the uses of sensors have expanded beyond the more traditional fields of temperature, pressure or flow measurement.
- Moreover, analog sensors such as potentiometers and force-sensing resistors are still widely used. Applications include manufacturing and machinery, airplanes and aerospace, cars, medicine and robotics.
- A sensor's sensitivity indicates how much the sensor's output changes when the input quantity being measured changes.
- For instance, if the mercury in a thermometer moves 1 cm when the temperature changes by 1 °C, the sensitivity is 1 cm/°C .
- Sensors need to be designed to have a small effect on what is measured; making the sensor smaller often improves this and may introduce other advantages.
- Technological progress allows more and more sensors to be manufactured on a microscopic scale as microsensors using MEMS technology.
- In most cases, a microsensor reaches a significantly higher speed and sensitivity compared with macroscopic approaches.

ZENER DIODE:-

- A properly doped crystal diode which has a sharp breakdown voltage is known as a **Zener Diode**.
- It has already been discussed that when the reverse bias on a crystal diode is increased, a critical voltage, called **Breakdown Voltage** is reached where the reverse current increases sharply to a high value.
- The breakdown region is the knee of the reverse characteristic as shown in Fig.

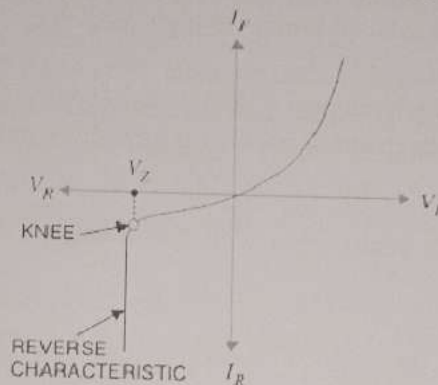

- The satisfactory explanation of this breakdown of the junction was first given by the American scientist C. Zener.
- The breakdown voltage is sometimes called **Zener Voltage** and the sudden increase in current is known as **Zener Current**.
- The breakdown or Zener voltage depends upon the amount of doping. If the diode is heavily doped, depletion layer will be thin and consequently the breakdown of the junction will occur at a lower reverse voltage.
- On the other hand, a lightly doped diode has a higher breakdown voltage.



- The given figure shows the symbol of a Zener diode. It may be seen that it is just like an ordinary diode except that the bar is turned into z-shape.
- The following points may be noted about the Zener diode:
1. A Zener diode is like an ordinary diode except that it is properly doped to have a sharp breakdown voltage.
 2. A Zener diode is always reverse connected i.e. it is always reverse biased.
 3. A Zener diode has sharp breakdown voltage, called Zener voltage V_Z .
 4. When forward biased, its characteristics are just those of ordinary diode.
 5. The Zener diode is not immediately burnt just because it has entered the breakdown region.
- As long as the external circuit connected to the diode limits the diode current to less than burn out value, the diode will not burn out.

- Zener diode operated in this region will have a relatively constant voltage across it, regardless of the value of current through the device. This permits the Zener diode to be used as a **Voltage Regulator**.

❖ TUNNEL DIODE:-

- Under normal forward bias operation, as voltage begins to increase, electrons at first tunnel through the very narrow p-n junction barrier because filled electron states in the conduction band on the n-side become aligned with empty valence band hole states on the p-side of the p-n junction.
- As voltage increases further these states become more misaligned and the current drops – this is called *negative resistance* because current decreases with increasing voltage.
- As voltage increases yet further, the diode begins to operate as a normal diode, where electrons travel by conduction across the p-n junction, and no longer by tunneling through the p-n junction barrier.
- The most important operating region for a tunnel diode is the negative resistance region.
- When used in the reverse direction, tunnel diodes are called **back diodes** (or **backward diodes**) and can act as fast rectifiers with zero offset voltage and extreme linearity for power signals (they have an accurate square law characteristic in the reverse direction).
- Under reverse bias, filled states on the p-side become increasingly aligned with empty states on the n-side and electrons now tunnel through the pn junction barrier in reverse direction.
- In a conventional semiconductor diode, conduction takes place while the p-n junction is forward biased and blocks current flow when the junction is reverse biased. This occurs up to a point known as the “reverse breakdown voltage” when conduction begins (often accompanied by destruction of the device).
- In the tunnel diode, the dopant concentrations in the p and n layers are increased to the point where the **reverse breakdown voltage** becomes **zero** and the diode conducts in the reverse direction.
- However, when forward-biased, an odd effect occurs called quantum mechanical tunnelling which gives rise to a region where an *increase* in forward voltage is accompanied by a *decrease* in forward current.
- In the current voltage characteristics of **tunnel diode**, we can find a negative slope region when forward bias is applied.

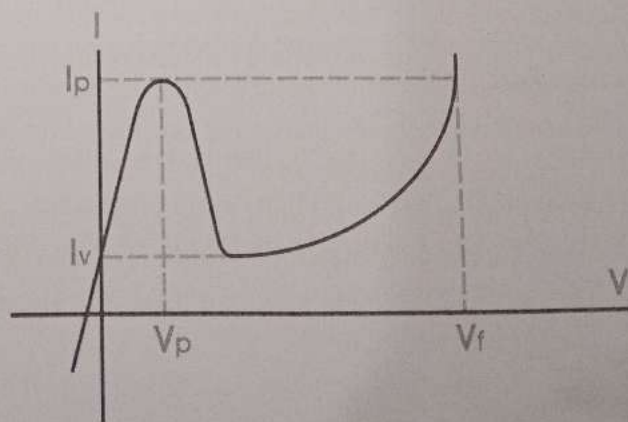

- Quantum mechanical tunneling is responsible for the phenomenon and thus this device is named as tunnel diode.
- The doping is very high so at absolute zero temperature the Fermi levels lies within the bias of the semiconductors. When no bias is applied any current flows through the junction.

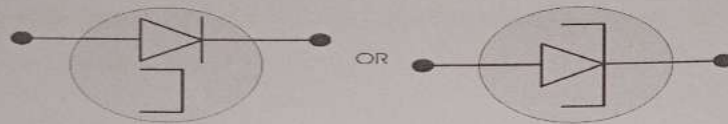

❖ PIN DIODE:-

- The PIN diode can be shown diagrammatically as being a PN junction, but with an intrinsic layer between the P and N layers.
- The intrinsic layer of the PIN diode is a layer without doping, and as a result this increases the size of the depletion region - the region between the P and N layers where there are no majority carriers. This change in the structure gives the PIN diode its unique properties.

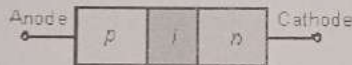

Basic PIN diode structure

- The PIN diode operates in exactly the same way as a normal diode.
- The only real difference is that the depletion region, that normally exists between the P and N regions in an unbiased or reverse biased diode is larger.
- In any PN junction, the P region contains holes as it has been doped to ensure that it has a predominance of holes.
- Similarly the N region has been doped to contain excess electrons.
- The region between the P and N regions contains no charge carriers as any holes or electrons combine. As the depletion region has no charge carriers it acts as an insulator.
- Within a PIN diode the depletion region exists, but if the diode is forward biased, the carriers enter the depletion region (including the intrinsic region) and as the two carrier types meet, current starts to flow.
- When the diode is forward biased, the carrier concentration, i.e. holes and electrons is very much higher than the intrinsic level carrier concentration.
- Due to this high level injection level, the electric field extends deeply (almost the entire length) into the region.
- This electric field helps in speeding up of the transport of charge carriers from p to n region, which results in faster operation of the diode, making it a suitable device for high frequency operations.
- A PIN diode obeys the standard diode equation for low frequency signals.

At higher frequencies, the diode looks like an almost perfect (very linear, even for large signals) resistor.

- There is a lot of stored charge in the intrinsic region.
- At low frequencies, the charge can be removed and the diode turns off.
- At higher frequencies, there is not enough time to remove the charge, so the diode never turns off. The PIN diode has a poor reverse recovery time.
- The high-frequency resistance is inversely proportional to the DC bias current through the diode.
- A PIN diode, suitably biased, therefore acts as a variable resistor.
- This high-frequency resistance may vary over a wide range (from 0.1 ohm to 10 k Ω in some cases the useful range is smaller, though).
- The wide intrinsic region also means the diode will have a low capacitance when reverse biased.
- In a PIN diode, the depletion region exists almost completely within the intrinsic region.
- This depletion region is much larger than in a PN diode, and almost constant-size, independent of the reverse bias applied to the diode.
- This increases the volume where electron-hole pairs can be generated by an incident photon.

❖ PIN DIODE USES AND ADVANTAGES

- The PIN diode is used in a number of areas as a result of its structure providing some properties which are of particular use.
 1. **HIGH VOLTAGE RECTIFIER:** The PIN diode can be used as a high voltage rectifier. The intrinsic region provides a greater separation between the PN and N regions, allowing higher reverse voltages to be tolerated.
 2. **RF SWITCH:** The PIN diode makes an ideal RF switch. The intrinsic layer between the P and N regions increases the distance between them. This also decreases the capacitance between them, thereby increasing the level of isolation when the diode is reverse biased.
 3. **PHOTODETECTOR:** As the conversion of light into current takes place within the depletion region of a photodiode, increasing the depletion region by adding the intrinsic layer improves the performance by increasing the volume in which light conversion occurs.

CHAPTER - 3

[RECTIFIERS]

❖ INTRODUCTION: -

- For reasons associated with economics of generation and transmission, the electric power available is usually an A.C. Supply. The supply voltage varies sinusoidal and has a frequency of 50 Hz. It is used for lighting, heating and electric motors.
- But there are many applications (e.g. electronic circuits) where D.C. supply is needed. When such a D.C. Supply is required, the mains A.C. Supply is rectified by using *Crystal Diodes*.
- The following two rectifier circuits can be used: -
 - (i) Half-wave rectifier (ii) Full-wave rectifier

➤ HALF-WAVE RECTIFIER:-

- In half-wave rectification, the rectifier conducts current only during the positive half-cycles of input A.C. Supply.
- The negative half-cycles of A.C. Supply is suppressed i.e. during negative half-cycles, no current is conducted and hence no voltage appears across the load.
- Therefore,

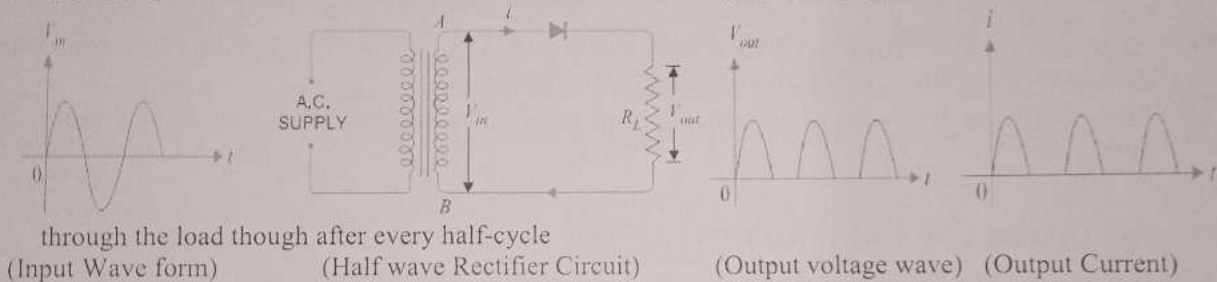

➤ Circuit Details: -

- The above Fig shows the circuit where a single crystal diode acts as a half-wave rectifier.
- The A.C. Supply to be rectified is applied in series with the diode and load resistance R_L . Generally, A.C. Supply is given through a transformer.
- The *use of transformer* permits two advantages.
 - ✓ Firstly, it allows us to step up or step down the A.C. input voltage as the situation demands.
 - ✓ Secondly, the transformer isolates the rectifier circuit from power line and thus reduces the risk of electric shock.

➤ OPERATION:-

- The A.C. voltage across the secondary winding AB changes polarities after every half-cycle.
- During the positive half-cycle of input A.C. voltage, end A becomes positive w.r.t. end B. This makes the diode forward biased and hence it conducts current.
- During the negative half-cycle, end A is negative w.r.t. end B. Under this condition, the diode is reverse biased and it conducts no current.
- Therefore, current flows through the diode during positive half-cycles of input A.C. voltage only; it is blocked during the negative half-cycles. In this way, current flows through load R_L always in the same direction. Hence D.C. output is obtained across R_L .
- It may be noted that output across the load is *pulsating D.C.* These pulsations in the output are further smoothed with the help of filter circuits discussed later.

➤ Disadvantages: -

- (i) The pulsating current in the load contains alternating component whose basic frequency is equal to the supply frequency. Therefore, an elaborate filtering is required to produce steady direct current.
- (ii) The A.C. supply delivers power only half the time. Therefore, the output is low.

❖ FULL-WAVE RECTIFIER: -

- In full-wave rectification, current flows through the load in the same direction for both half-cycles of input A.C. voltage. This can be achieved with two diodes working alternately.
- For the positive half-cycle of input voltage, one diode supplies current to the load and for the negative half-cycle, the other diode does so ; current being always in the same direction through the load.
- Therefore, a full-wave rectifier utilizes both half-cycles of input A.C. voltage to produce the D.C. output.
- The following two circuits are commonly used for full-wave rectification: -
 - (i) Centre-tap full-wave rectifier
 - (ii) Full-wave bridge rectifier

❖ CENTRE-TAP FULL-WAVE RECTIFIER:-

✚ Circuit Details: -

- The circuit employs two diodes D_1 and D_2 as shown in Fig below. A centre tapped secondary winding AB is used with two diodes connected so that each uses one half-cycle of input A.C. voltage.
- In other words, diode D_1 utilizes the A.C. voltage appearing across the upper half (OA) of secondary winding for rectification while diode D_2 uses the lower half winding OB.

✚ Circuit Operation: -

- During the positive half-cycle of secondary voltage, the end A of the secondary winding becomes positive and end B negative. This makes the diode D_1 forward biased and diode D_2 reverse biased.
- Therefore, diode D_1 conducts while diode D_2 does not. The conventional current flow is through diode D_1 , load resistor R_L and the upper half of secondary winding as shown by the dotted arrows.
- During the negative half-cycle, end A of the secondary winding becomes negative and end B positive.
- Therefore, diode D_2 conducts while diode D_1 does not. The conventional current flow is through diode D_2 , load R_L & lower half winding shown by solid arrows.
- It may be seen that current in the load R_L is in the same direction for both half-cycles of input A.C. voltage. Therefore, D.C. is obtained across the load R_L .

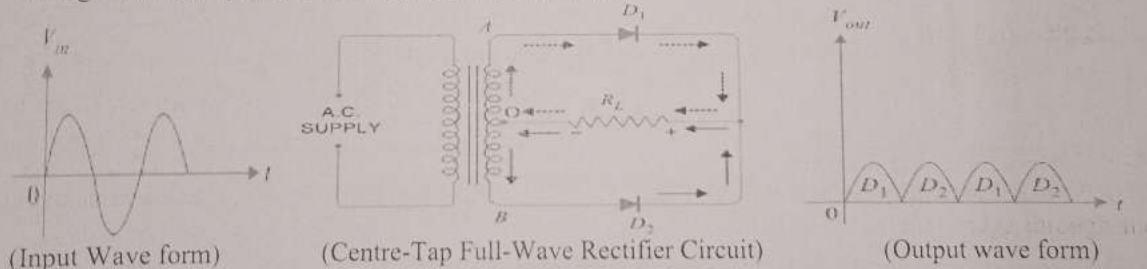

✚ Advantages:-

- (i) The D.C. output voltage and load current values are twice than that of a half wave rectifier.
- (ii) The ripple factor is much less (0.482) than that of half rectifier (1.21).
- (iii) The efficiency is twice (81.2%) than that of half wave rectifier (40.6%).

✚ Disadvantages:-

- (i) It is difficult to locate the centre tap on the secondary winding.
- (ii) The D.C. output is small as each diode utilizes only one-half of the transformer secondary voltage.
- (iii) The diodes used must have high peak inverse voltage.

❖ FULL-WAVE BRIDGE RECTIFIER: -

✚ Circuit Details: -

- The need for a centre tapped power transformer is eliminated in the bridge rectifier.
- It contains four diodes D_1 , D_2 , D_3 and D_4 connected to form bridge as shown in Fig below.
- The A.C. supply to be rectified is applied to the diagonally opposite ends of the bridge through the transformer.
- Between other two ends of the bridge, the load resistance R_L is connected.

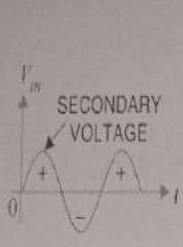

(Input Wave Form)

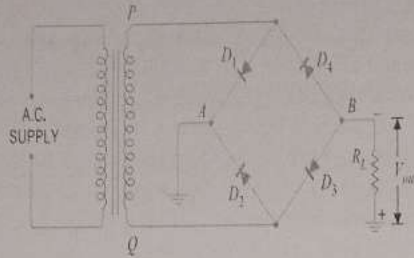

(Full-Wave Bridge Rectifier Circuit)

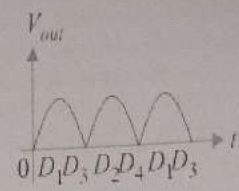

(Output wave form)

➤ **CIRCUIT OPERATION :-**

- During the positive half-cycle of secondary voltage, the end P of the secondary winding becomes positive and end Q negative.
- This makes diodes D_1 and D_3 forward biased while diodes D_2 and D_4 are reverse biased.
- Therefore, only diodes D_1 and D_3 conduct. These two diodes will be in series through the load R_L as shown in Fig. below. The conventional current flow is shown by dotted arrows. It may be seen that current flows from A to B through the load R_L .
- During the negative half-cycle of secondary voltage, end P becomes negative and end Q positive. This makes diodes D_2 and D_4 forward biased whereas diodes D_1 and D_3 are reverse biased.
- Therefore, only diodes D_2 and D_4 conduct. These two diodes will be in series through the load R_L as shown in Fig. below. The current flow is shown by the solid arrows.
- It may be seen that again current flows from A to B through the load i.e. in the same direction as for the positive half-cycle. Hence, D.C. output is obtained across load R_L .

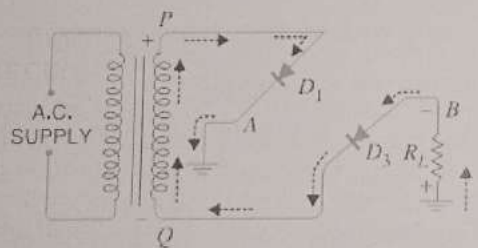

(Full-Wave Bridge Rectifier Circuit in +ve Half Cycle)

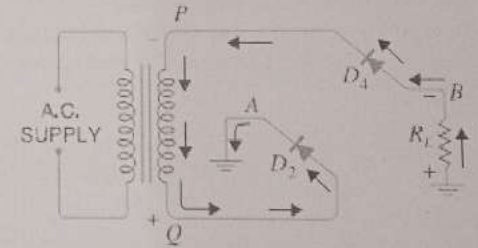

(Full-Wave Bridge Rectifier Circuit -ve Half Cycle)

➤ **Advantages: -**

- (i) The need for centre-tapped transformer is eliminated.
- (ii) The output is twice that of the centre-tap circuit for the same secondary voltage.
- (iii) The PIV is one-half that of the centre-tap circuit (for same D.C. output).

➤ **Disadvantages: -**

- (i) It requires four diodes. (ii) Internal resistances high.

➤ **Mathematical Derivation for Rectification Efficiency for HALF WAVE rectifier :-**

➤ The ratio of d.c. power output to the applied input a.c. power is known as rectifier efficiency i.e.,

$$\text{Rectifier efficiency, } \eta = \frac{\text{d.c. power output}}{\text{Input a.c. power}}$$

- Consider a half-wave rectifier shown in Fig.
- Let $v = V_m \sin \theta$ be the alternating voltage that appears across the secondary winding. Let r_f and R_L be the diode resistance and load resistance respectively.
- The diode conducts during positive half-cycles of a.c. supply while no current conduction takes place during negative half-cycles.

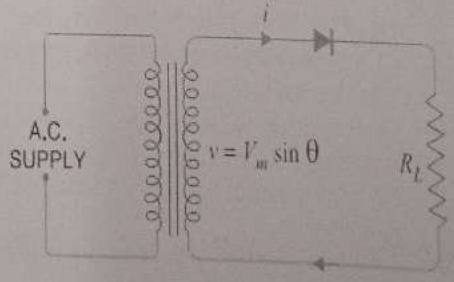

❖ **OUTPUT D.C. POWER :-**

➤ The output current is pulsating direct current. Therefore, in order to find D.C. power, average current has to be found out.

$$\begin{aligned} \text{Average Value} &= \frac{\text{Area Under The Curve Over a cycle}}{\text{Base}} = \int_0^\pi \frac{i \, d\theta}{2\pi} \\ I_{av} = I_{dc} &= \frac{1}{2\pi} \int_0^\pi i \, d\theta = \frac{1}{2\pi} \int_0^\pi \frac{V_m \sin \theta}{r_f + R_L} \, d\theta = \frac{V_m}{2\pi(r_f + R_L)} \int_0^\pi \sin \theta \, d\theta \\ &= \frac{V_m \sin \theta}{r_f + R_L} [-\cos \theta]_0^\pi = \frac{V_m}{2\pi(r_f + R_L)} \times [(-\cos \pi) - (-\cos 0)] \\ &= \frac{V_m}{2\pi(r_f + R_L)} \times 2 = \frac{V_m}{(r_f + R_L)} \times \frac{1}{\pi} = \frac{I_m}{\pi} \quad [\because I_m = \frac{V_m}{(r_f + R_L)}] \end{aligned}$$

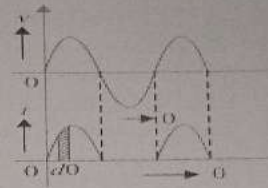

∴ D.C. Power, $P_{dc} = I_{dc}^2 \times R_L = \left(\frac{I_m}{\pi}\right)^2 \times R_L$

❖ **INPUT A.C. POWER :-**

➤ The A.C. power input is given by : $P_{ac} = I_{rms}^2 (r_f + R_L)$ For a half-wave rectified wave, $I_{rms} = I_m/2$

∴ $P_{ac} = \left(\frac{I_m}{2}\right)^2 \times (r_f + R_L)$

∴ Rectifier efficiency = $\frac{\text{d.c. output power}}{\text{a.c. input power}} = \frac{(I_m/\pi)^2 \times R_L}{(I_m/2)^2 (r_f + R_L)} = \frac{0.406 R_L}{r_f + R_L} = \frac{0.406 R_L}{1 + \frac{r_f}{R_L}}$

The efficiency will be maximum if r_f is negligible as compared to R_L .

∴ **Max. Rectifier Efficiency for HALF WAVE Rectifier = 40.6%**

➤ It shows that in half-wave rectification, maximum of 40.6% of a.c. power is converted into d.c. power.

NOTE:- $I_{rms} = \left[\frac{1}{2\pi} \int_0^{2\pi} i^2 \, d\theta\right]^{1/2} = \left[\frac{1}{2\pi} \int_0^\pi I_m^2 \sin^2 \theta \, d\theta + \frac{1}{2\pi} \int_\pi^{2\pi} 0 \, d\theta\right]^{1/2} = \left[\frac{I_m^2}{2\pi} \int_0^\pi \frac{1 - \cos 2\theta}{2} \, d\theta\right]^{1/2}$
 $= \left[\frac{I_m^2}{4\pi} \left[\theta - \frac{\sin 2\theta}{2}\right]_0^\pi\right]^{1/2} = \left[\frac{I_m^2}{4\pi} \left[\pi - 0 - \frac{\sin 2\pi}{2} + \sin 0\right]\right]^{1/2} = \left[\frac{I_m^2}{4\pi} \times \pi\right]^{1/2} = \left[\frac{I_m^2}{4}\right]^{1/2} = \frac{I_m}{2} \rightarrow I_{rms} = \frac{I_m}{2}$

Similarly, $V_{rms} = V_m/2$ for Half Wave and For Full Wave Rectifier $I_{rms} = I_m/\sqrt{2}$ and $V_{rms} = V_m/\sqrt{2}$

❖ **Mathematical Derivation for Rectification Efficiency for FULL WAVE Rectifier :-**

- Fig. shows the process of full-wave rectification.
- Let $v = V_m \sin \theta$ be the a.c. voltage to be rectified. Let r_f and R_L be the diode resistance and load resistance respectively.
- Obviously, the rectifier will conduct current through the load in the same direction for both half-cycles of input a.c. voltage. The instantaneous current i is given by :

$$i = \frac{v}{(r_f + R_L)} = \frac{V_m \sin \theta}{(r_f + R_L)}$$

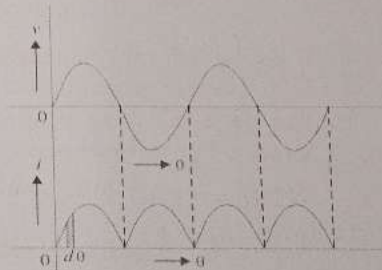

❖ **D.C. OUTPUT POWER.**

➤ The output current is pulsating direct current. Therefore, in order to find the d.c. power, average current has to be found out. For a full wave rectifier the average value or dc value can be found like half wave ,

$$I_{dc} = \frac{2I_m}{\pi}$$

∴ D.C. power output, $P_{dc} = I_{dc}^2 \times R_L = \left(\frac{2I_m}{\pi}\right)^2 \times R_L$

❖ **A.C. INPUT POWER.**

➤ The a.c. input power is given by : $P_{ac} = I_{rms}^2 (r_f + R_L)$

For a full-wave rectified wave, we have, $I_{rms} = I_m/\sqrt{2}$ ∴ $P_{ac} = \left(\frac{I_m}{\sqrt{2}}\right)^2 (r_f + R_L)$

∴ Full-wave rectification efficiency is

$$\eta = \frac{P_{dc}}{P_{ac}} = \frac{(2I_m/\pi)^2 R_L}{\left(\frac{I_m}{\sqrt{2}}\right)^2 (r_f + R_L)} = \frac{8}{\pi^2} \times \frac{R_L}{(r_f + R_L)} = \frac{0.812 R_L}{r_f + R_L} = \frac{0.812}{1 + \frac{r_f}{R_L}}$$

The efficiency will be maximum if r_f is negligible as compared to R_L . ∴ Maximum efficiency = 81.2%

➤ This is double the efficiency due to half-wave rectifier. Therefore, a full-wave rectifier is twice as effective as a half-wave rectifier.

➤ **RIPPLE FACTOR: -**

- The output of a rectifier consists of a d.c. component and an a.c. component (also known as ripple).
- The a.c. component is undesirable and accounts for the pulsations in the rectifier output.
- The effectiveness of a rectifier depends upon the magnitude of a.c. component in the output; the smaller this component, the more effective is the rectifier.
- Ripple mean unwanted ac signal present in the rectified output.
- The ratio of R.M.S. value of A.C. component to the D.C. component in the rectifier output is known as *ripple factor* i.e.

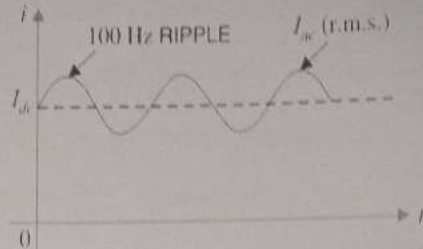

$$\text{Ripple factor} = \frac{\text{r.m.s. value of a.c. component}}{\text{value of d.c. component}} = \frac{I_{ac}}{I_{dc}}$$

❖ **Mathematical Analysis.**

- The output current of a rectifier contains d.c. as well as a.c. component.
- By definition, the effective (i.e. r.m.s.) value of total load current is given by :

$$I_{rms} = \sqrt{I_{dc}^2 + I_{ac}^2} \quad \text{Or} \quad I_{ac} = \sqrt{I_{rms}^2 - I_{dc}^2}$$

- Dividing throughout by I_{dc} , we get,

$$\frac{I_{ac}}{I_{dc}} = \frac{1}{I_{dc}} \sqrt{I_{rms}^2 - I_{dc}^2} \quad (\text{But } I_{ac}/I_{dc} \text{ is the ripple factor.})$$

$$\therefore \text{Ripple factor} = \frac{1}{I_{dc}} \sqrt{I_{rms}^2 - I_{dc}^2} = \sqrt{\left(\frac{I_{rms}}{I_{dc}}\right)^2 - 1}$$

(i) **For half-wave rectification: -**

$$\text{In half-wave rectification, } I_{rms} = I_m/2 \quad ; \quad I_{dc} = I_m/\pi$$

$$\therefore \text{Ripple factor} = \sqrt{\left(\frac{I_m/2}{I_m/\pi}\right)^2 - 1} = 1.21$$

- It is clear that a.c. component exceeds the d.c. component in the output of a half-wave rectifier.
- This results in greater pulsations in the output.
- Therefore, half-wave rectifier is ineffective for conversion of a.c. into d.c.

(ii) **For full-wave rectification: -**

$$\text{In full-wave rectification, } I_{rms} = \frac{I_m}{\sqrt{2}} \quad ; \quad I_{dc} = \frac{2I_m}{\pi}$$

$$\therefore \text{Ripple factor} = \sqrt{\left(\frac{I_m/\sqrt{2}}{2I_m/\pi}\right)^2 - 1} = 0.48 \quad \text{i.e.} \quad \frac{\text{effective a.c. component}}{\text{d.c. component}} = 0.48$$

- This shows that in the output of a full-wave rectifier, the d.c. component is more than the a.c. component. Consequently, the pulsations in the output will be less than in half-wave rectifier.
- For this reason, full-wave rectification is invariably used for conversion of a.c. into d.c.

➤ **Peak Inverse Voltage (PIV) : -**

- The maximum value of reverse voltage occurs at the peak of the input cycle, which is equal to V_m .
- This maximum reverse voltage is called peak inverse voltage (PIV). Thus the PIV of diode : -
 a) For Half Wave = V_m , b) For Center Tapped = $2V_m$ and c) For Bridge Rectifier = V_m .

➤ **Transformer Utilization Factor (TUF) : -**

- It may be defined as the ratio of d.c. power delivered to the load and the a.c. rating of the transformer secondary.

Thus,

$$\text{TUF} = P_{dc} / P_{ac}$$

- For half wave rectifier, TUF = 0.287; Center taped rectifier, TUF = 0.693; Bridge rectifier, TUF = 0.812.
- The TUF is very useful in determining the rating of a transformer to be used with rectifier circuit.

➤ **Average Value of Voltage & Current for HALF WAVE Rectifiers: -**

➤ If V_m = Maximum value of the a.c. input voltage, then the average or d.c. value of the output voltage and current is given by

$$V_{dc} = V_m/\pi = 0.318 V_m \quad \text{and} \quad I_{dc} = I_m/\pi = 0.318 I_m$$

➤ **Average Value of Voltage & Current for FULL WAVE Rectifiers: -**

➤ If V_m = Maximum value of the a.c. input voltage, then the average or d.c. value of the output voltage and current is given by

$$V_{dc} = 2V_m/\pi = 0.636 V_m \quad \text{and} \quad I_{dc} = 2I_m/\pi = 0.636 I_m$$

➤ **Output Frequency of Half Wave Rectifier: -**

- The output frequency of a half-wave rectifier is equal to the input frequency (50 Hz). Recall how a complete cycle is defined.
- A waveform has a complete cycle when it repeats the same wave pattern over a given time.
- Thus in Fig. (i), the a.c. input voltage repeats the same wave pattern over $0^\circ - 360^\circ$, $360^\circ - 720^\circ$ and so on.
- In Fig. (ii), the output waveform also repeats the same wave pattern over $0^\circ - 360^\circ$, $360^\circ - 720^\circ$ and so on.
- This means that when input a.c. completes one cycle, the output half wave rectified wave also completes one cycle.
- In other words, for the half wave rectifier the output frequency is equal to the input frequency i.e. $f_{out} = f_{in}$
- For example, if the input frequency of sine wave applied to a half-wave rectifier is 100 Hz, then frequency of the output wave will also be 100 Hz.

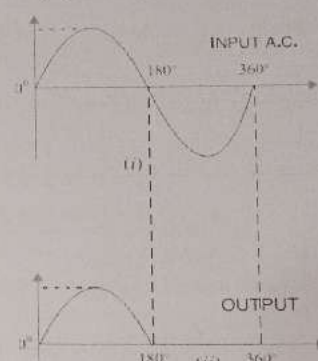

➤ **Output Frequency of Full Wave Rectifier: -**

- The output frequency of a full-wave rectifier is double the input frequency.
- As a wave has a complete cycle when it repeats the same pattern.
- In Fig. (i), the input a.c. completes one cycle from $0^\circ - 360^\circ$.
- However, in Fig. (ii) full-wave rectified wave completes two cycles in this period.
- Therefore, output frequency is twice the input frequency i.e. $f_{out} = 2f_{in}$
- For example, if the input frequency to a full-wave rectifier is 100 Hz, then the output frequency will be 200 Hz.

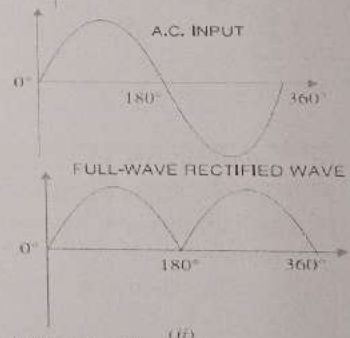

➤ **COMPARISON OF RECTIFIERS: -**

Rectifier type: Half-wave

Full-wave Centre-tap

Bridge Rectifier

Schematic diagram:

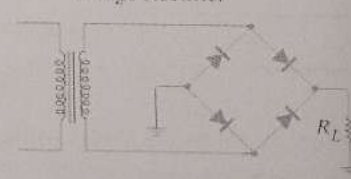
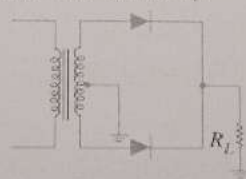
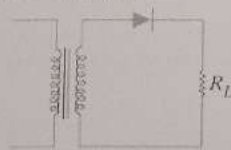

Typical output waveform:

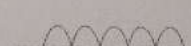

S. No.	Particulars	Half-wave	Centre-tap	Bridge type
1	No. of diodes	1	2	4
2	Transformer necessary	no	yes	no
3	Max. efficiency	40.6%	81.2%	81.2%
4	Ripple factor	1.21	0.48	0.48
5	Output frequency	f_{in}	$2f_{in}$	$2f_{in}$
6	Peak inverse voltage	V_m	$2V_m$	V_m

❖ **FILTER CIRCUITS:-**

- Generally, a rectifier is required to produce pure D.C. supply for using at various places in the electronic circuits.
- However, the output of a rectifier has pulsating character i.e. it contains A.C. and D.C. components.
- The A.C. component is undesirable and must be kept away from the load.
- To do so, a filter circuit is used which removes (or filters out) the A.C. component and allows only the D.C. component to reach the load.
- A **filter circuit** is a device which removes the A.C. component of rectifier output but allows the D.C. component to reach the load.
- A filter circuit is generally a combination of inductors (L) and capacitors (C).
- The filtering action of L and C depends upon the basic electrical principles.
- A capacitor offers infinite reactance to d.c.
- We know that $X_C = 1/2\pi fC$. But for D.C., $f = 0$.
 - ∴ $X_C = 1/2\pi fC = 1/2\pi \times 0 \times C = \infty$ (Means Capacitor shows *infinite reactance* to DC)
 - ♣ **Hence, a Capacitor does not allow d.c. to pass through it.**
- We know $X_L = 2\pi fL$. For d.c., $f = 0$
 - ∴ $X_L = 2\pi \times 0 \times L = 0$ (Means Inductor shows *zero reactance* to DC)
 - ♣ **Hence Inductor passes d.c. quite readily.**
- A Capacitor passes A.C. but does not pass D.C. at all. On the other hand, an Inductor opposes A.C. but allows D.C. to pass through it.
- It then becomes clear that suitable network of L and C can effectively remove the A.C. component, allowing the D.C. component to reach the load.

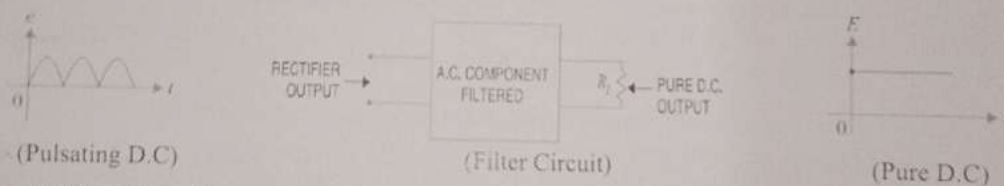

➤ **Types Of Filter Circuits:-**

➤ There are different types of filter circuits according to their construction. The most commonly used filter circuits are :-

- ♣ Inductive Filter or Series Inductor,
- ♣ Capacitor Filter or Shunt Capacitor,
- ♣ Choke Input Filter or LC Filter and
- ♣ Capacitor Input Filter or π -Filter.

✓ **Inductive Filter Or Series Inductor:-**

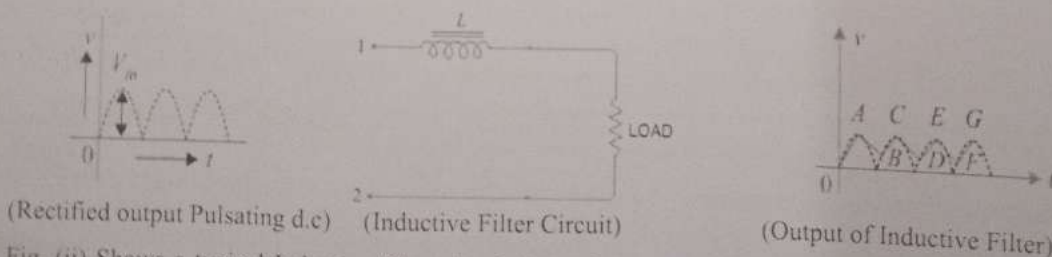

➤ Fig. (ii) Shows a typical Inductive filter circuit. It consists of an Inductor L placed across the rectifier output in series with load R_L .

- The choke (Inductor with iron core) offers high opposition to the passage of a.c. component but no opposition to the d.c. component.
- The result is that most of the a.c. component appears across the choke while whole of d.c. component passes through the choke on its way to load. This results in the reduced pulsations at Load resistance R_L .
- ✓ **Capacitor Filter Or Shunt Capacitor:-**

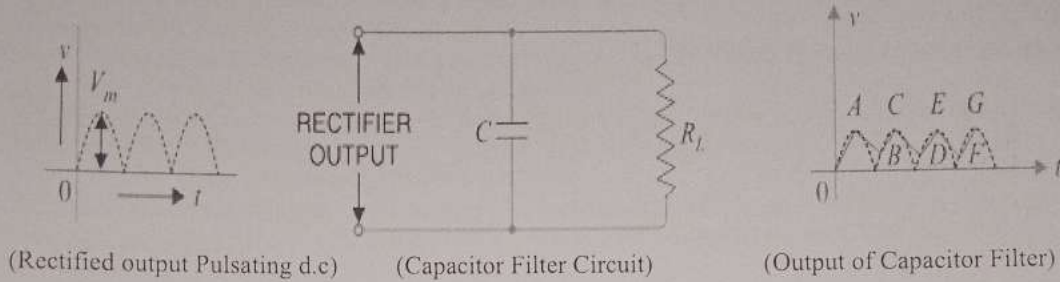

- Fig. (ii) Shows a typical capacitor filter circuit. It consists of a capacitor C placed across the rectifier output in parallel with load R_L .
- The pulsating direct voltage of the rectifier is applied across the capacitor. As the rectifier voltage increases, it charges the capacitor and also supplies current to the load.
- At the end of quarter cycle [Point A in Fig. (iii)], the capacitor is charged to the peak value V_m of the rectifier voltage.
- Now, the rectifier voltage starts to decrease. As this occurs, the capacitor discharges through the load and voltage across it decreases as shown by the line AB in Fig. (iii).
- The voltage across load will decrease only slightly because immediately the next voltage peak comes and recharges the capacitor.
- This process is repeated again and again and the output voltage waveform becomes ABCDEFG. It may be seen that very little ripple is left in the output.
- Moreover, output voltage is higher as it remains substantially near the peak value of rectifier output voltage.
- The capacitor filter circuit is extremely popular because of its low cost, small size, little weight and good characteristics.

✓ **Choke Input Filter Or LC Filter:-**

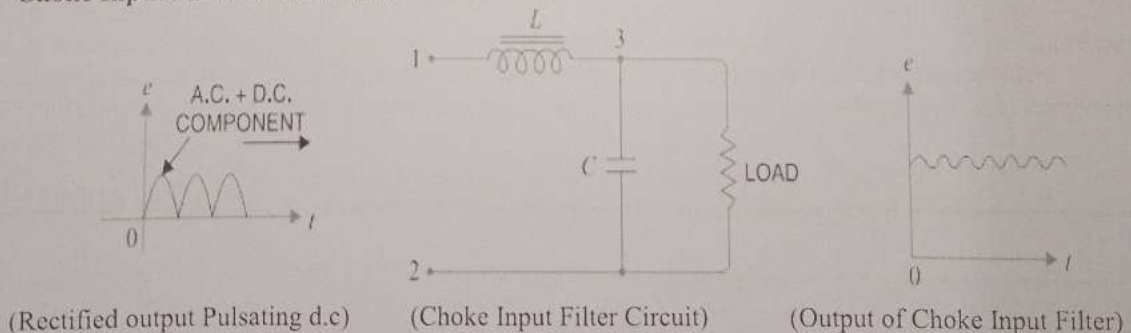

- Fig. shows a typical choke input filter circuit. It consists of a choke L connected in series with the rectifier output and a filter capacitor C across the load.
- Only a single filter section is shown, but several identical sections are often used to reduce the pulsations as effectively as possible.
- The pulsating output of the rectifier is applied across terminals 1 and 2 of the filter circuit.
- As discussed before, the pulsating output of rectifier contains a.c. and d.c. components. The choke offers high opposition to the passage of a.c. component but negligible opposition to the d.c. component.
- The result is that most of the a.c. component appears across the choke while whole of d.c. component passes through the choke on its way to load. This results in the reduced pulsations at terminal 3.

- At terminal 3, the rectifier output contains d.c. component and the remaining part of a.c. component which has managed to pass through the choke.
- Now, the low reactance of filter capacitor bypasses the a.c. component but prevents the d.c. component to flow through it. Therefore, only d.c. component reaches the load.
- In this way, the filter circuit has filtered out the a.c. component from the rectifier output, allowing d.c. component to reach the load.

✓ **Capacitor Input Filter or π -Filter:-**

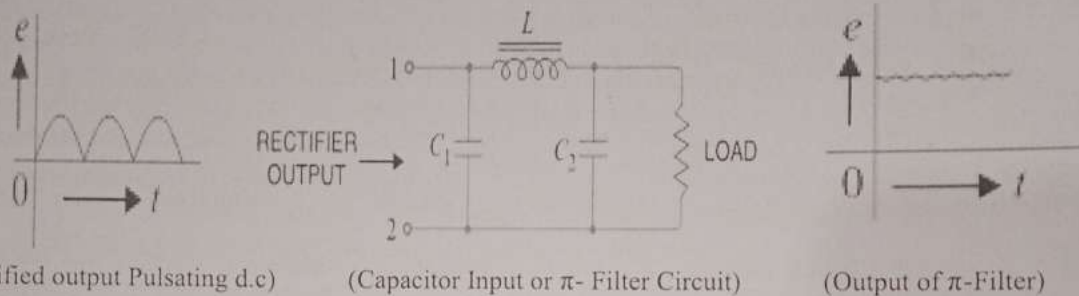

- Fig. shows a typical capacitor input filter or π -filter. It consists of a filter capacitor C_1 connected across the rectifier output, a choke L in series and another filter capacitor C_2 connected across the load.
- Only one filter section is shown but several identical sections are often used to improve the smoothing action. The pulsating output from the rectifier is applied across the input terminals (i.e. terminals 1 & 2) of the filter.
- The filtering action of the three components viz C_1 , L and C_2 of this filter is described below :
 - (a) The **filter capacitor C_1** offers low reactance to a.c. component of rectifier output while it offers infinite reactance to the d.c. component. Therefore, capacitor C_1 bypasses an appreciable amount of a.c. component while the d.c. component continues its journey to the choke L .
 - (b) The **choke L** offers high reactance to the a.c. component but it offers almost zero reactance to the d.c. component. Therefore, it allows the d.c. component to flow through it, while the un bypassed a.c. component is blocked.
 - (c) The **filter capacitor C_2** bypasses the a.c. component which the choke has failed to block. Therefore, only d.c. component appears across the load and that is what we desire

CHAPTER - 4

[TRANSISTORS]

❖ INTRODUCTION:-

- When a third doped element is added to a crystal diode in such a way that two PN junctions are formed, the resulting device is known as a **Transistor**.
- This is a new type of electronics device which can able to amplify a weak signal in a fashion comparable and often superior to that realized by vacuum tubes.
- A transistor consists of two PN junctions formed by sandwiching either p-type or n-type semiconductor between a pair of opposite types. Hence Transistor is classified into two types, namely: -
 - (i) n-p-n transistor (ii) p-n-p transistor
- An n-p-n transistor is composed of two n-type semiconductors separated by a thin section of p-type.
- However, a p-n-p transistor is formed by two p-sections separated by a thin section of n-type as shown in Figure below.

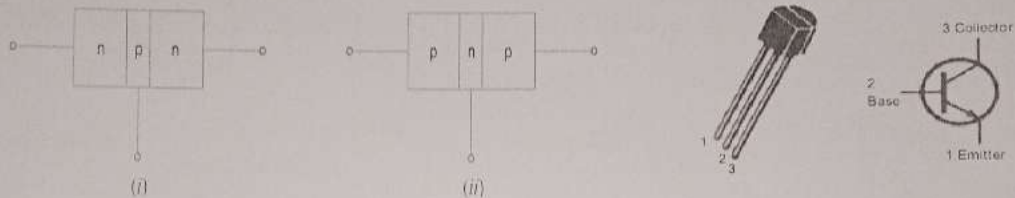

❖ NAMING: -

- A transistor has *two pn junctions*. As discussed later, one junction is forward biased and the other is reverse biased.
- The *forward biased junction* has a low resistance path whereas a *reverse biased junction* has a high resistance path.
- The weak signal is introduced in the low resistance circuit and output is taken from the high resistance circuit. Therefore, a transistor transfers a signal from a low resistance to high resistance.
- The prefix '**trans**' means the signal transfer property of the device while '**istor**' classifies it as a solid element in the same general family with resistors.

❖ NAMING THE TRANSISTOR TERMINALS:-

- ✗ A transistor (PNP or NPN) has three sections of doped semiconductors.
- ✗ The section on one side is the **emitter** and the section on the opposite side is the **collector**.
- ✗ The middle section is called the **base** and forms two junctions between the emitter and collector.
- + (i) **Emitter: -**
- ✗ The section on one side that *supplies charge carriers* (electrons or holes) is called the emitter.
- ✗ The emitter is always forward biased w.r.t. base so that it can supply a large number of majority carriers.
- ✗ The emitter (p-type) of PNP transistor is forward biased and supplies hole charges to its junction with the base. Similarly the emitter (n-type) of NPN transistor has a forward bias and supplies free electrons to its junction with the base.
- + (ii) **Collector: -**
- ✗ The section on the other side that *collects the charges* is called the collector. The collector is always reverse biased. Its function is to remove charges from its junction with the base.
- ✗ The collector (p-type) of PNP transistor has a reverse bias and receives hole charges that flow in the output circuit. Similarly the collector (n-type) of NPN transistor has reverse bias & receives electrons.
- + (iii) **Base: -**
- ✗ The middle section which forms two PN-junctions between emitter & collector is called base.
- ✗ The base-emitter junction is forward biased, allowing low resistance for the emitter circuit.

- The base-emitter junction is forward biased & provides low resistance for the emitter [PAGE - 4, 2ct.]
- The base-collector junction is reverse biased and provides high resistance in the collector circuit.

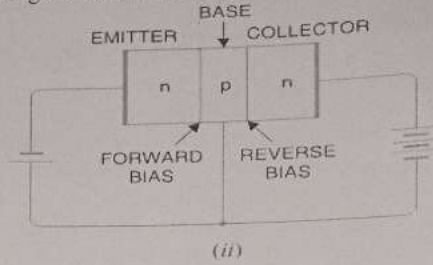
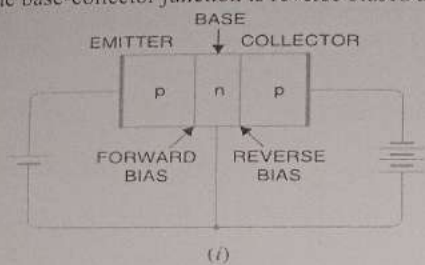

❖ TRANSISTOR SYMBOL:-

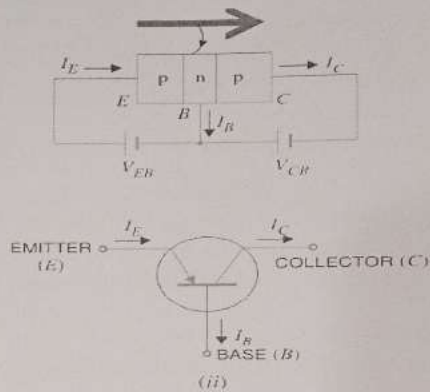
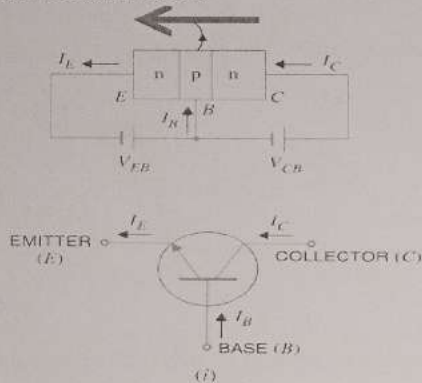

❖ WORKING OF NPN TRANSISTOR (NPN): -

- The NPN transistor with forward bias to emitter-base junction & reverse bias to collector-base junction.
- The forward bias causes the electrons in the n-type emitter to flow towards the base.
- This constitutes the emitter current I_E . As these electrons flow through the p-type base, they tend to combine with holes.
- As the base is lightly doped and very thin, therefore, only a few electrons (less than 5%) combine with holes to constitute base current I_B .
- The remainders (more than 95%) cross over into the collector region to constitute collector current I_C .
- In this way, almost the entire emitter current flows in the collector circuit.
- It is clear that emitter current is the sum of collector and base currents i.e. $I_E = I_B + I_C$

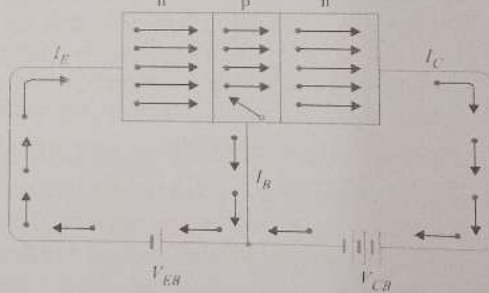

❖ WORKING OF PNP TRANSISTOR (PNP): -

- Fig. shows the basic connection of a PNP transistor.
- The forward bias causes the holes in the p-type emitter to flow towards the base.
- This constitutes the emitter current I_E .
- As these holes cross into n-type base, they tend to combine with the electrons.
- As the base is lightly doped and very thin, therefore, only a few holes (less than 5%) combine with the electrons. The remainder (more than 95%) cross into the collector region to constitute collector current I_C .
- In this way, almost the entire emitter current flows in the collector circuit.

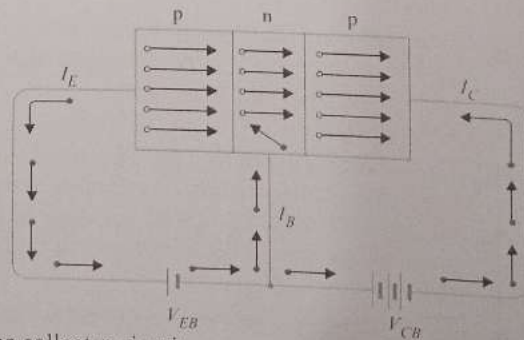

➤ The current conduction within PNP transistor is by holes. However, in the external connecting wires, the current is still by electrons.

- It may be noted that current conduction within PNP transistor is by holes. However, in the external connecting wires, the current is still by electrons
- ❖ **TRANSISTOR CONNECTIONS:-**
- There are three leads in a transistor such as emitter, base and collector terminals.
- However, when a transistor is to be connected in a circuit, we require **four terminals**; two for the input and two for the output.
- This difficulty is overcome by making one terminal of it in common to both input and output terminals.
- The input is fed between this common terminal and one of the other two terminals.
- The output is obtained between the common terminal and the remaining terminal.
- So a transistor can be connected in a circuit in the following ways:-

(i) Common Base connection (ii) Common Emitter connection (iii) Common Collector connection

➤ **(i) Common Base Connection**

In this circuit arrangement, input is applied between emitter and base and output is taken from collector and base.

Here, base of the transistor is common to both input and output circuits and hence the name Common Base connection. A Common Base NPN and PNP in figure below.

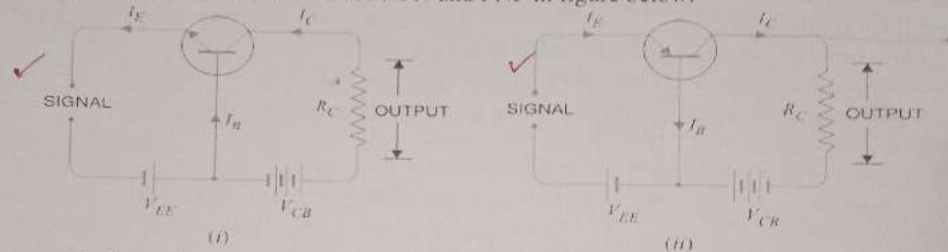

➤ **(ii) Common Emitter Connection**

In this circuit arrangement, input is applied between base and emitter and output is taken from the collector and emitter.

Here, emitter of the transistor is common to both input and output circuits and hence the name Common Emitter connection. A Common Emitter NPN and PNP transistor circuit is shown in figure below.

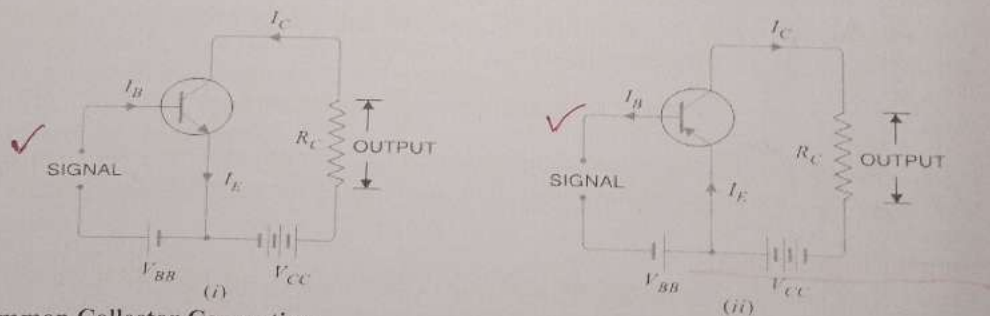

➤ **(iii) Common Collector Connection**

In this circuit arrangement, input is applied between base and collector while output is taken between the emitter and collector.

Here, collector of the transistor is common to both input and output circuits and hence the name Common Collector connection. A Common Collector NPN and PNP in figure below.

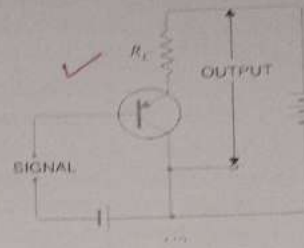
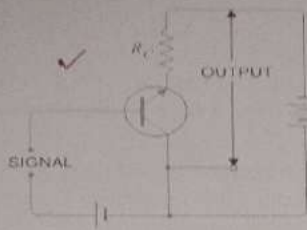

❖ **TRANSISTOR CHARACTERISTICS:-**

➤ **1) Characteristics of Common Base Connection**

- The complete electrical behavior of a transistor can be described by stating the interrelation of the various currents and voltages.
- These relationships can be conveniently displayed graphically and the curves thus obtained are known as the characteristics of transistor.
- The most important characteristics of common base connection are **input characteristics** and **output characteristics**.

A) **Input Characteristics:-**

- It is the curve between emitter current I_E & emitter-base voltage V_{EB} at constant collector-base voltage V_{CB} .
- The emitter current is generally taken along y-axis and emitter-base voltage along x-axis. Fig. Shows the input characteristics of a typical transistor in CB arrangement.
- The following points may be noted from these characteristics :
 - ✦ The emitter current I_E increases rapidly with small increase in emitter-base voltage V_{EB} . It means that input resistance is very small.
 - ✦ The emitter current is almost independent of collector-base voltage V_{CB} . This leads to the conclusion that emitter current (and hence collector current) is almost independent of collector voltage.

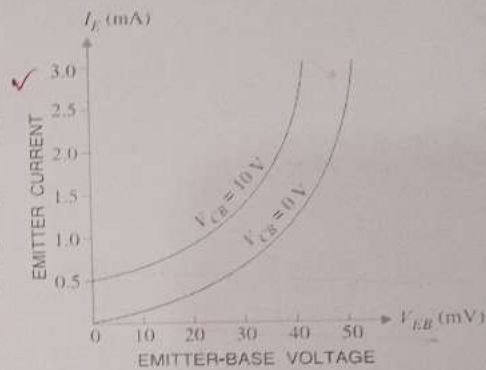

- **Input Resistance:** - It is the ratio of change in emitter-base voltage (ΔV_{EB}) to the resulting change in emitter current (ΔI_E) at constant collector-base voltage (V_{CB}) i.e.

$$\text{Input resistance, } r_i = \frac{\Delta V_{BE}}{\Delta I_E} \text{ at constant } V_{CB}$$

- In fact, input resistance is the opposition offered to the signal current. As a very small V_{EB} is sufficient to produce a large flow of emitter current I_E , thus, input resistance is quite small, of the order of a few ohms.

B) **Output Characteristics:-**

- It is the curve between collector current I_C & collector-base voltage V_{CB} at constant emitter current I_E .
- Generally, collector current is taken along y-axis and collector-base voltage along x-axis.
- The fig. shows the input and output characteristics of a typical transistor in CB arrangement.
- The following points may be noted from characteristics :

- ✦ The collector current I_C varies with V_{CB} only at very low voltages ($< 1V$). The transistor is never operated in this region.
- ✦ When the value of V_{CB} is raised above 1 – 2 V, the collector current becomes constant as indicated by straight horizontal curves. It means that now I_C is independent of V_{CB} and depends upon I_E only. This is consistent with the theory that the emitter current

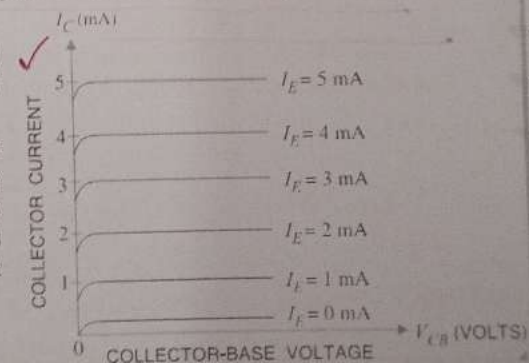

flows almost entirely to the collector terminal. The transistor is always operated in this region.

- ✦ A very large change in collector-base voltage produces only a tiny change in collector current. This means that output resistance is very high.

➤ **Output Resistance:** - It is the ratio of change in collector-base voltage (ΔV_{CB}) to the resulting change in collector current (ΔI_C) at constant emitter current i.e.

$$\text{Output resistance, } r_o = \frac{\Delta V_{CB}}{\Delta I_C} \text{ at constant } I_E$$

➤ The output resistance of CB circuit is very high, of the order of several tens of kilo-ohms.

✦ **2) Characteristics of Common Emitter Connection:-**

➤ The important characteristics of this circuit arrangement are the input characteristic and output characteristic.

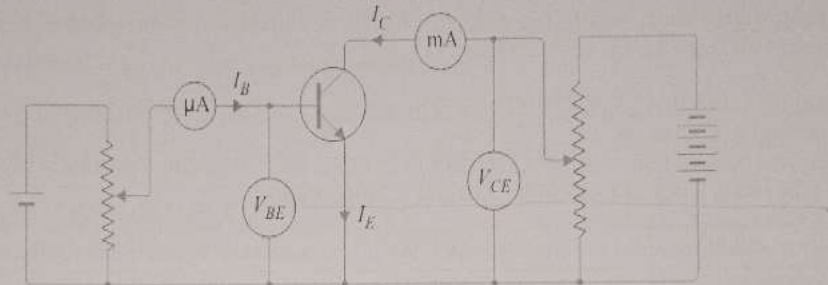

(Circuit Arrangement for studying Common Emitter Connection of Transistor)

A) **Input Characteristics:-**

➤ It is the curve between base current I_B & base-emitter voltage V_{BE} at constant collector-emitter volt V_{CE} . The input characteristics of a CE connection can be determined by the circuit shown in Fig. Keeping V_{CE} constant (Let 10 V), note the base current I_B for various values of V_{BE} .

➤ Then plot the readings obtained on the graph, taking I_B along y-axis and V_{BE} along x-axis. This gives the input characteristic at $V_{CE} = 10V$ as shown in Fig.

➤ The following points may be noted from the characteristics :

- ✦ The characteristic resembles that of a forward biased diode curve. This is expected since the base-emitter section of transistor is a diode and it is forward biased.
- ✦ As compared to CB arrangement, I_B increases less rapidly with V_{BE} . Therefore, input resistance of a CE circuit is higher than that of CB circuit.

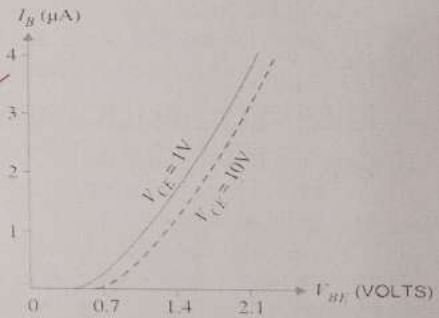

➤ **Input Resistance:** - It is the ratio of change in base-emitter voltage (ΔV_{BE}) to the change in base current (ΔI_B) at constant V_{CE} . The value of input resistance for CE circuit is of the order of a few hundred ohms

B) **Output Characteristics:-**

➤ It is the curve between collector current I_C and collector-emitter voltage V_{CE} at constant base current I_B .

➤ The output characteristics of CE circuit can be drawn with the help of above circuit arrangement in Fig.

➤ Keeping the base current I_B fixed at some value say, $5 \mu A$, note the collector current I_C for various values of V_{CE} .

➤ Then plot the readings on a graph, taking I_C along y-axis and V_{CE} along x-axis.

➤ This gives the output characteristic at $I_B = 5 \mu A$ as shown in Fig. The test can be repeated for $I_B = 10 \mu A$ to obtain the new output characteristic as shown in Fig.

➤ Following similar procedure, a family of output characteristics can be drawn as shown in Fig.

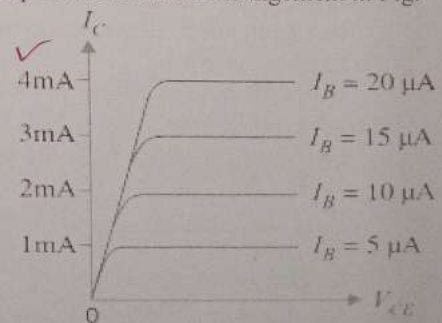

- The following points may be noted from the characteristics:
 - ✦ (i) The collector current I_C varies with V_{CE} for V_{CE} between 0 and 1V only. After this, I_C becomes almost constant & independent of V_{CE} .
 - ✦ This value of V_{CE} upto which I_C changes with V_{CE} is called the knee voltage (V_{knee}). The transistors are always operated in the region above knee voltage.
 - ✦ (ii) Above knee voltage, I_C is almost constant. However, a small increase in I_C with increasing V_{CE} is caused by the collector depletion layer getting wider and capturing a few more majority carriers before electron-hole combinations occur in the base area.
 - ✦ (iii) For any value of V_{CE} above knee voltage, the collector current I_C is approximately equal to $\beta \times I_B$.
- **Output Resistance:** - It is the ratio of change in collector-emitter voltage (ΔV_{CE}) to the change in collector current (ΔI_C) at constant I_B i.e.
$$\text{Output resistance, } r_o = \frac{\Delta V_{CE}}{\Delta I_C} \text{ at constant } I_B$$
- It may be noted that whereas the output characteristics of CB circuit are horizontal, they have noticeable slope for the CE circuit.
- Therefore, output resistance of CE circuit is less than that CB circuit. Its value is of the order of 50 k Ω .
- ✦ **3) Characteristics of Common Collector Connection:-**
- In a Common Collector circuit connection the load resistor connected from emitter to ground, so the collector tied to ground even though the transistor is connected in a manner similar to the CE connection.
- Hence there is no need for a set of common-collector characteristic to choose the parameters of the circuit. The output characteristic of the CC configuration is same as CE configuration.
- For CC Connection the output characteristic are plot of I_E versus V_{CE} for a constant value of I_B .
- There is an almost unnoticeable change in the vertical scale of I_C of the CE connection if I_C is replaced by I_E for CC connection.
- The input circuit of CC connection, the CE characteristic is sufficient to obtain the required information.
- Hence Common Collector circuit connection is known as **Emitter Follower**.
- ✦ **CURRENT AMPLIFICATION FACTORS:** - (It is the ratio of output current to input current)

1) Common Base Connection:-

In a common base connection, the input current is the Emitter Current I_E and output current is the Collector Current I_C .

Hence the ratio of change in collector current to the change in emitter current at constant collector-base voltage V_{CB} is known as current amplification factor for CB Connection and is denoted as α (Alpha).

- ✦ Practical values of α in commercial transistors range from 0.9 to 0.99.

2) Common Emitter Connection:-

In a common emitter connection, the input current is the Base Current I_B and output current is the Collector Current I_C .

Hence ratio of change in collector current (I_C) to the change in base current (I_B) at constant collector-emitter voltage V_{CE} is known as current amplification factor for CE Connection and denoted as β (Beta).

- ✦ Usually, its value ranges from 20 to 500.

3) Common Collector Connection:-

In a common collector connection, the input current is the Emitter Current I_E and output current is the Emitter Current I_E .

Hence the ratio of change in emitter current to the change in base current at constant V_{CC} is known as current amplification factor for CC Connection and is denoted as γ (Gamma).

- ✦ This circuit provides about the same current gain as the common emitter circuit as $\Delta I_E \approx \Delta I_C$.

$$\alpha = \frac{\Delta I_C}{\Delta I_E}$$

$$\beta = \frac{\Delta I_C}{\Delta I_B}$$

$$\gamma = \frac{\Delta I_E}{\Delta I_B}$$

❖ RELATION AMONG DIFFERENT CURRENT AMPLIFICATION FACTORS:-

$$\Delta I_E = \Delta I_B + \Delta I_C$$

1) Relation between α and β :-

$$\ast \text{ As, } \beta = \frac{\Delta I_C}{\Delta I_B} = \frac{\Delta I_C}{\Delta I_E - \Delta I_C} = \frac{\Delta I_C / \Delta I_E}{1 - \Delta I_C / \Delta I_E} = \frac{\alpha}{1 - \alpha} \rightarrow \text{ As, } \alpha = \frac{\Delta I_C}{\Delta I_E} = \frac{\Delta I_C}{\Delta I_B + \Delta I_C} = \frac{\Delta I_C / \Delta I_E}{1 + \Delta I_C / \Delta I_E} = \frac{\beta}{1 + \beta}$$

2) Relation between α and γ :-

$$\ast \text{ As, } \gamma = \frac{\Delta I_E}{\Delta I_B} = \frac{\Delta I_E}{\Delta I_E - \Delta I_C} = \frac{\Delta I_E / \Delta I_E}{1 - \Delta I_C / \Delta I_E} = \frac{1}{1 - \alpha} \rightarrow \text{ As, } \alpha = \frac{\Delta I_C}{\Delta I_E} = \frac{\Delta I_E - \Delta I_B}{\Delta I_E} = \frac{\Delta I_E / \Delta I_B - 1}{\Delta I_E / \Delta I_B} = \frac{\gamma - 1}{\gamma}$$

3) Relation between β and γ :-

$$\ast \text{ As, } \gamma = \frac{\Delta I_E}{\Delta I_B} = \frac{\Delta I_B + \Delta I_C}{\Delta I_B} = \frac{\Delta I_B}{\Delta I_B} + \frac{\Delta I_C}{\Delta I_B} = 1 + \beta \rightarrow \text{ As, } \beta = \frac{\Delta I_C}{\Delta I_B} = \frac{\Delta I_E - \Delta I_B}{\Delta I_B} = \frac{\Delta I_E}{\Delta I_B} - \frac{\Delta I_B}{\Delta I_B} = \gamma - 1$$

4) Relation between α , β and γ :-

$$\ast \text{ As, } \beta = \frac{\alpha}{1 - \alpha} = \alpha \times \frac{1}{1 - \alpha} = \alpha \times \gamma$$

$$\therefore \beta = \alpha \times \gamma$$

$$\therefore \alpha = \frac{\beta}{1 + \beta}$$

$$\therefore \beta = \frac{\alpha}{1 - \alpha}$$

$$\therefore \gamma = \frac{1}{1 - \alpha}$$

$$\therefore \alpha = \frac{\gamma - 1}{\gamma}$$

$$\therefore \gamma = 1 + \beta$$

$$\therefore \beta = \gamma - 1$$

❖ COMPARISON OF TRANSISTOR CONNECTIONS:-

S. No.	Characteristic	Common base	Common emitter	Common collector
1.	Input resistance	Low (about 100 Ω)	Low (about 750 Ω)	Very high (about 750 k Ω)
2.	Output resistance	Very high (about 450 k Ω)	High (about 45 k Ω)	Low (about 50 Ω)
3.	Voltage gain	about 150	about 500	less than 1
4.	Applications	For high frequency applications	For audio frequency applications	For impedance matching
5.	Current gain	No (less than 1)	High (β)	Appreciable

- ❖ Out of the three transistor connections, the **Common Emitter Circuit** is the most efficient.
- ❖ It is used in about 90 to 95 per cent of all transistor applications.
- ❖ The main reasons for the widespread use of this circuit arrangement are :
(i) High current gain. (ii) High voltage and power gain. (iii) Moderate output to input impedance ratio.

❖ **AMPLIFIER:-**

- The device which increases the strength of a weak signal is known as *Amplifier*. This can achieve by use of Transistor. It may be classified according to the number of stage of amplification, Such as:-
- ✓ **Single Stage Transistor Amplifier:** - When only one transistor with associated circuitry is used for amplifying a weak signal, the circuit is known as *Single Stage Transistor Amplifier*.
- ✓ **Multi stage Transistor Amplifier:**-When a transistor circuit containing more than one stage of amplification is known as *Multi stage Transistor Amplifier*.

➤ **SINGLE STAGE TRANSISTOR AMPLIFIER:-**

- A single stage transistor amplifier has one transistor, bias circuit and other auxiliary components.
- When a weak A.C. signal is given to the base of transistor, a small base current starts flowing.
- Due to transistor action, a much larger (β times the base current) current flows through the collector load R_C .
- As the value of R_C is quite high (usually 4-10 k Ω), therefore, a large voltage appears across R_C .
- Thus, a weak signal applied in the base circuit appears in amplified form in the collector circuit.
- It is in this way that a transistor acts as an amplifier.

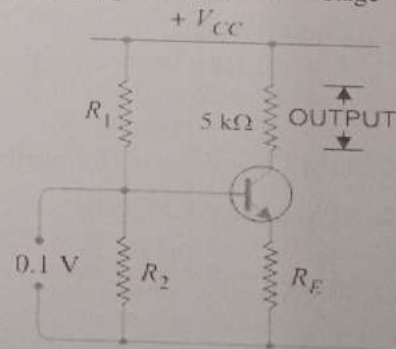

[Transistor as an Amplifier]

CHAPTER - 5

[TRANSISTOR CIRCUITS]

❖ TRANSISTOR BIASING:-

- The basic function of transistor is to do amplification. The weak signal is given to the base of the transistor and amplified output is obtained in the collector circuit.
- One important requirement during amplification is that only the magnitude of the signal should increase and there should be no change in signal shape.
- This increase in magnitude of the signal without any change in shape is known as *faithful amplification*.
- For this we have to provide input circuit (i.e. base-emitter junction) remains forward biased and output circuit (i.e. collector-base junction) remains reverse biased at all times.
- To achieve faithful amplification the following basic conditions must be satisfied:-
 - (i) Proper zero signal collector current
 - (ii) Minimum proper base-emitter voltage (V_{BE}) at any instant
 - (iii) Minimum proper collector-emitter voltage (V_{CE}) at any instant
- The fulfillment of these will ensure that transistor works over the active region of the output characteristics.
- The proper flow of zero signal collector current and the maintenance of proper collector-emitter voltage during the passage of signal is known as *Transistor Biasing*.
- The basic purpose of transistor biasing is to keep the base-emitter junction properly forward biased and collector-base junction properly reverse biased during the application of signal.
- This can be achieved with a bias battery or associating a circuit with a transistor.
- The second method i.e. with a bias battery or associating a circuit with a transistor is more efficient and is frequently employed.
- The circuit which provides transistor biasing is known as biasing circuit. The transistor biasing is very essential for the proper operation of transistor in any circuit.

✓ NEED OF TRANSISTOR BIASING:-

- (i) It should ensure proper zero signal collector current.
- (ii) It should ensure that V_{CE} does not fall below 0.5 V for Ge transistors and 1 V for Si transistors.
- (iii) It should ensure the stabilization of operating point.

❖ STABILISATION: -

- The process of making operating point independent of temperature changes or variations in transistor parameters is known as *Stabilization*.

❖ NEED FOR STABILIZATION:- Stabilization of the operating point is necessary due to the following reasons :

- ✦ (i) Temperature dependence of IC
- ✦ (ii) Individual variations
- ✦ (iii) Thermal runaway
- The self-destruction of an unsterilized transistor is known as *Thermal Runaway*.

❖ STABILITY FACTOR :-

- The rate of change of collector current I_C w.r.t. the collector leakage current I_{CO} [= I_{C60}] at constant β and I_B is called stability factor i.e.

$$\text{Stability factor, } S = \frac{dI_C}{dI_{CO}} \text{ at constant } I_B \text{ and } \beta$$

✓ **METHODS OF TRANSISTOR BIASING:-**

➤ In the transistor amplifier circuits drawn so far biasing was done with the aid of a battery V_{BB} which was separate from the battery V_{CC} used in the output circuit. However, for simplicity and economy, it is desirable that transistor circuit should have a single source of supply the one in the output circuit (i.e. V_{CC}).

➤ The following are the most commonly used methods of obtaining transistor biasing from one source of supply:

- (i) Base resistor method
- (ii) Biasing with collector-feedback resistor
- (iii) Voltage-divider bias

➤ In all these methods, the same basic principle is employed i.e. required value of base current (and hence I_C) is obtained from V_{CC} in the zero signal conditions.

➤ The value of collector load R_C is selected keeping in view that V_{CE} should not fall below 0.5 V for germanium transistors and 1V for silicon transistors.

❖ **BASE RESISTOR METHOD:-**

- In this method, a high resistance R_B (several hundred $k\Omega$) is connected between the base and +ve end of supply for npn transistor and between base and negative end of supply for pnp transistor.
- Here, the required zero signal base current is provided by V_{CC} and it flows through R_B . It is because now base is positive w.r.t. emitter i.e. base-emitter junction is forward biased.
- The required value of zero signal base current I_B (and hence $I_C = \beta I_B$) can be made to flow by selecting the proper value of base resistor R_B .

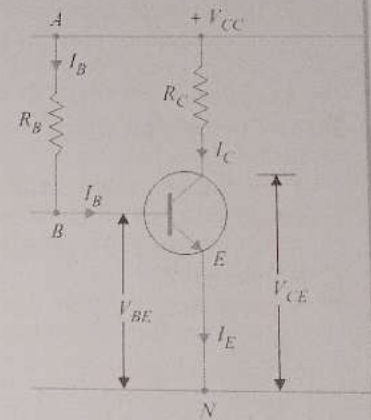

➤ **Circuit analysis:-**

It is required to find the value of R_B so that required collector current flows in the zero signal conditions.

Let I_C be the required zero signal collector current.

$$\therefore I_B = I_C / \beta$$

Considering the closed circuit ABENA and applying Kirchhoff's voltage law, we get,

$$V_{CC} = I_B R_B + V_{BE}$$

$$I_B R_B = V_{CC} - V_{BE}$$

$$R_B = \frac{V_{CC} - V_{BE}}{I_B} \dots \dots \dots (i)$$

As V_{CC} and I_B are known and V_{BE} can be seen from the transistor manual, therefore, value of R_B can found from exp. (i).

Since V_{BE} is generally quite small as compared to V_{CC} , the former can be neglected with little error.

Thus Equation (i) becomes, $R_B = \frac{V_{CC}}{I_B}$

➤ It may be noted that V_{CC} is a fixed known quantity and I_B is chosen at some suitable value. Hence, R_B can always be found directly, and for this reason, this method is sometimes called **fixed-bias method**.

➤ **Advantages :**

- (i) This biasing circuit is very simple as only one resistance R_B is required.
- (ii) Biasing conditions can easily be set and the calculations are simple.

➤ **Disadvantages :**

- (i) This method provides poor stabilization.
- (ii) The stability factor is very high.

❖ **BIASING WITH FEEDBACK CIRCUIT:-**

➤ In this method, one end of R_B is connected to the base and the other end to the collector. Here, the required zero signal base current is determined not by V_{CC} but by the collector-base voltage V_{CB} . It is clear that V_{CB} forward biases the base-emitter junction and hence base current I_B flows through R_B . This causes the zero signal collector current to flow in the circuit.

➤ **Circuit Analysis:-**

The required value of R_B needed to give the zero signal current I_C can be determined as follows.
From the above circuit diagram, $V_{CC} = I_C R_C + I_B R_B + V_{BE}$

$$R_B = \frac{V_{CC} - V_{BE} - I_C R_C}{I_B} = \frac{V_{CC} - V_{BE} - \beta I_B R_C}{I_B} \quad (\because I_C = \beta I_B)$$

Alternately, $V_{CE} = V_{BE} + V_{CB}$ or $V_{CB} = V_{CE} - V_{BE}$

$$\therefore R_B = \frac{V_{CB}}{I_B} = \frac{V_{CE} - V_{BE}}{I_B}; \text{ where } I_B = \frac{I_C}{\beta}$$

➤ **Advantages :-**

- (i) It is a simple method as it requires only one resistance R_B .
- (ii) This circuit provides some stabilization of the operating point than fixed bias method.

➤ **Disadvantages:-**

- (i) The circuit does not provide good stabilization.
- (ii) This circuit provides a negative feedback which reduces the gain of the amplifier.
- (iii) This will reduce the base current and hence collector current.

❖ **VOLTAGE DIVIDER BIAS METHOD:-**

➤ This is the most widely used method of providing biasing and stabilization to a transistor. In this method, two resistances R_1 and R_2 are connected across the supply voltage V_{CC} and provide biasing. The emitter resistance R_E provides stabilization. The name "voltage divider" comes from the voltage divider formed by R_1 and R_2 . The voltage drop across R_2 forward biases the base-emitter junction. This causes the base current and hence collector current flows in the zero signal conditions.

➤ **Circuit analysis:-**

➤ Suppose that the current flowing through resistance R_1 is I_1 . As base current I_B is very small, therefore, it can be assumed with reasonable accuracy that current flowing through R_2 is also I_1 .

(i) Collector current I_C :-

$$I_1 = \frac{V_{CC}}{R_1 + R_2}$$

\therefore Voltage across resistance R_2 is

$$V_2 = \left(\frac{V_{CC}}{R_1 + R_2} \right) R_2$$

Applying Kirchhoff's voltage law to the base circuit

$$V_2 = V_{BE} + V_E = V_{BE} + I_E R_E$$

$$I_E = \frac{V_2 - V_{BE}}{R_E}; \quad I_C = \frac{V_2 - V_{BE}}{R_E}; \quad \text{Since } I_E \approx I_C$$

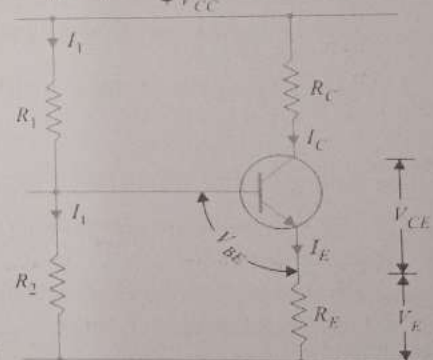

(Voltage Divider Bias Circuit)

➤ Thus I_C in this circuit is almost independent of transistor parameters and hence good stabilization is ensured. Due to this reason the potential divider bias has become universal method for providing transistor biasing.

(ii) Collector-emitter voltage (V_{CE}): -

Applying Kirchhoff's voltage law to the collector side,

$$V_{CC} = I_C R_C + V_{CE} + I_E R_E = I_C R_C + V_{CE} + I_C R_E \quad (\text{As } I_C \approx I_E)$$

$$\text{So, } V_{CC} = I_C (R_C + R_E) + V_{CE} \Rightarrow V_{CE} = V_{CC} - I_C (R_C + R_E)$$

➤ **Advantages :-**

➤ In this circuit, excellent stabilization is provided by R_E . Consider the Following Equation,

$$V_2 = V_{BE} + I_C R_E$$

➤ Suppose the collector current I_C increases due to rise in temperature. This will cause the voltage drop across emitter resistance R_E to increase.

CHAPTER - 6

[TRANSISTOR AMPLIFIERS & OSCILLATORS]

❖ D.C. AND A.C. EQUIVALENT CIRCUITS: -

➤ Various circuit currents. It is useful to mention the various currents in the complete amplifier circuit. These are shown in the circuit of Fig.

➤ (i) **Base Current:** - When no signal is applied in the base circuit, D.C. base current I_B flows due to biasing circuit. When A.C. signal is applied, A.C. base current i_b also flows.

➤ Therefore, with the application of signal, Total Base Current i_B is given by: $i_B = I_B + i_b$

➤ (ii) **Collector Current:** - When no signal is applied, a D.C. collector current I_C flows due to biasing circuit. When A.C. signal is applied, A.C. collector current i_c also flows.

➤ Therefore, the Total Collector Current i_C is given by: - $i_C = I_C + i_c$

Where $I_C = \beta I_B =$ zero signal collector current and $i_c = \beta i_b =$ collector current due to signal.

➤ (iii) **Emitter Current:** - When no signal is applied, a D.C. emitter current I_E flows. When A.C. signal is applied, A.C. Emitter Current i_e also flows. Therefore the Total Emitter Current is: - $i_E = I_E + i_e$

➤ It is useful to keep in mind that: $I_E = I_B + I_C$ and $i_e = i_b + i_c$.

➤ But base current is usually very small, therefore, as a reasonable approximation, $I_E \approx I_C$ and $i_e \approx i_c$.

❖ **D. C. Equivalent Circuit:** - In order to draw the equivalent D.C. circuit, the following two steps are applied to the transistor circuit:-

- (a) Reduce all A.C. sources to zero.
- (b) Open all the capacitors.

➤ Referring D.C. Equivalent Circuit

$$D.C. \text{ Load } R_{DC} = R_C + R_E \quad \& \quad V_{CC} = V_{CE} + I_C (R_C + R_E)$$

➤ The maximum value of V_{CE} will occur when there is no collector current i.e. $I_C = 0$.

$$\therefore \text{Maximum } V_{CE} = V_{CC}$$

➤ The maximum collector current will flow when $V_{CE} = 0$.

$$\therefore \text{Maximum } I_C = V_{CC} / (R_C + R_E)$$

❖ **A.C. Equivalent Circuit:** - In order to draw A.C. equivalent circuit, the following two steps are applied to the transistor circuit:

- (a) Reduce all D.C. sources to zero (i.e. $V_{CC} = 0$).
- (b) Short all the capacitors.

➤ Referring A.C. Equivalent circuit A.C. load equal to $R_C \parallel R_L$ i.e.

$$A.C. \text{ load, } R_{AC} = (R_C R_L / (R_C + R_L))$$

➤ Maximum positive swing of A.C. collector-emitter voltage = $I_C \times R_{AC}$

$$\therefore \text{Total maximum collector-emitter voltage, } V_{CE \text{ MAX}} = V_{CE} + I_C R_{AC}$$

➤ Maximum positive swing of A.C. collector current = V_{CE} / R_{AC}

$$\therefore \text{Total maximum collector current, } I_{C \text{ MAX}} = I_C + V_{CE} / R_{AC}$$

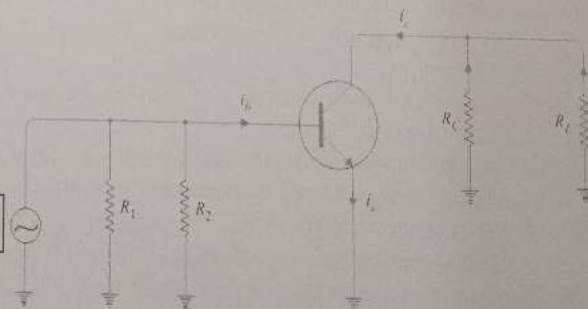
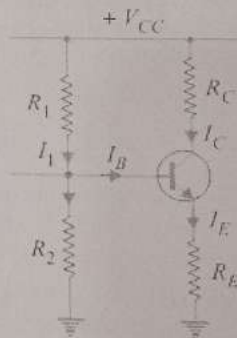
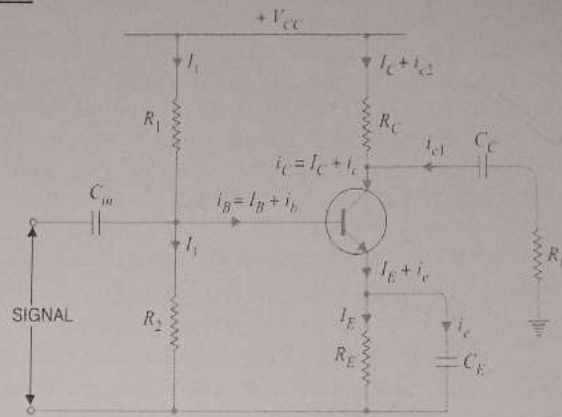

❖ **LOAD LINE ANALYSIS: -**

- In the transistor circuit analysis, it is generally required to determine the collector current for various collector-emitter voltages.
- One of the methods can be used to plot the output characteristics and determine the collector current at any desired collector-emitter voltage.
- However, a more convenient method, known as **load line method** can be used to solve such problems.
- This method is quite easy and is frequently used in the analysis of transistor applications.

❖ **D.C. LOAD LINE:** - It is the line on the output characteristics of a transistor circuit which gives the values of I_C and V_{CE} corresponding to zero signal or D.C. conditions.

➤ Consider a common emitter NPN transistor circuit where no signal is applied. Therefore, D.C. conditions prevail in the circuit. The output characteristics of this circuit are shown in Fig.

➤ The value of collector-emitter voltage V_{CE} at any time is given by:

$$V_{CE} = V_{CC} - I_C R_C \quad \text{Or} \quad I_C R_C = V_{CC} - V_{CE}$$

$$\text{Or} \quad I_C = \frac{V_{CC}}{R_C} - \frac{V_{CE}}{R_C}$$

$$\text{Or} \quad I_C = (-1/R_C) V_{CE} + V_{CC}/R_C \quad (\equiv Y = mX + C)$$

➤ As V_{CC} and R_C are fixed values, therefore, it is a first degree equation and can be represented by a straight line on the output characteristics. This is known as **D.C. Load Line**.

➤ To add load line, we need two end points of the straight line. These two points can be located as under:

(i) When the collector current $I_C = 0$, then collector-emitter voltage is maximum and is equal to V_{CC}
 i.e. $\text{Max. } V_{CE} = V_{CC} - I_C R_C = V_{CC} \quad (\text{As } I_C = 0)$

➤ This gives the first point B ($OB = V_{CC}$) on the collector-emitter voltage axis as shown in Fig.

(ii) When collector-emitter voltage $V_{CE} = 0$, the collector current is maximum and is equal to V_{CC}/R_C

$$\text{i.e. } V_{CE} = V_{CC} - I_C R_C \quad \text{or} \quad 0 = V_{CC} - I_C R_C$$

$$\therefore \text{Max. } I_C = V_{CC}/R_C$$

➤ This gives the second point A ($OA = V_{CC}/R_C$) on the collector current axis as shown in Fig.

➤ By joining these two points, **D.C. Load Line AB** is constructed.

❖ **(II) A.C. LOAD LINE.** This is the line on the output characteristics of a transistor circuit which gives the values of i_c and v_{ce} when signal is applied.

➤ Referring back to the transistor amplifier shown in Fig., its A.C. equivalent circuit as far as output circuit is concerned is as shown in Fig.

➤ To add A.C. load line to the output characteristics, we again require two end points: -

1. One maximum collector-emitter voltage point ($V_{CE \text{ MAX}}$) and
2. Other is maximum collector current point. ($I_C \text{ MAX}$)

➤ Under the application of A.C. signal, these values are Maximum collector-emitter voltage, $V_{CE \text{ MAX}} = V_{CE} + I_C R_{AC}$.

➤ This locates the point C of the A.C. load line on the collector-emitter voltage axis.

➤ Maximum collector current, $I_C \text{ MAX} = I_C + V_{CE}/R_{AC}$

➤ This locates the point D of A.C. load line on the collector-current axis.

➤ By joining points C and D, the **A.C. Load Line CD** is constructed.

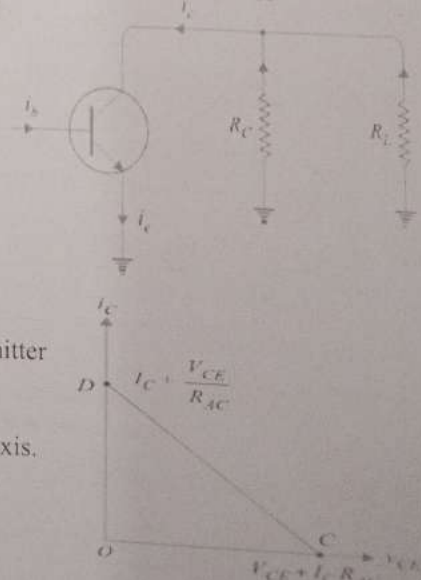
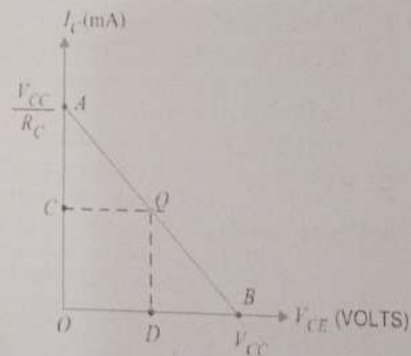
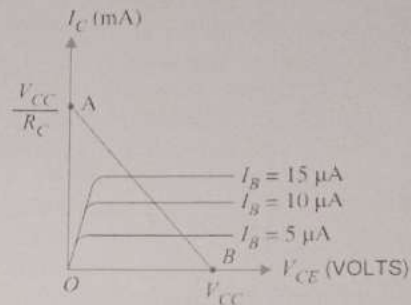

❖ **OPERATING POINT:-**

- The zero signal values of I_C and V_{CE} are known as the **Operating point**.
- It is called operating point because the variations of I_C and V_{CE} take place about this point when signal is applied.
- It is also called quiescent (silent) point or **Q-Point** because it is the point on $I_C - V_{CE}$ characteristic when the transistor is silent i.e. in the absence of the signal.
- Suppose in the absence of signal, the base current is $5\mu A$. Then I_C and V_{CE} conditions in the circuit must be represented by some point on $I_B = 5\mu A$ characteristic.
- But I_C and V_{CE} conditions in the circuit should also be represented by some point on the d. c. load line AB.
- The point Q where the load line and the characteristic intersect is the only point which satisfies both these conditions. Therefore, the point Q describes the actual state of affairs in the circuit in the zero signal conditions and is called the operating point. Referring to Fig. for $I_B = 5\mu A$, the zero signal values are :

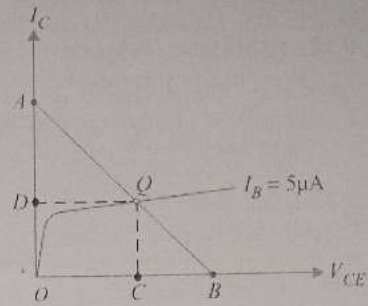

$$V_{CE} = OC \text{ volts} \quad I_C = OD \text{ mA}$$

- It follows, therefore, that the zero signal values of I_C and V_{CE} (i.e. operating point) are determined by the point where d.c. load line intersects at proper base current curve.

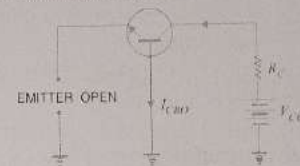

❖ **THE LEAKAGE CURRENT:-**

- The current is due to the movement of minority carriers is known as Leakage Current.
- In Common Base Connection of Transistor the leakage current I_{CBO} is the Collector-Base current with emitter open.
- Similarly, In Common Emitter Connection the leakage current I_{CEO} is the Collector-Emitter Current with open Base.
- Expression for collector current in Common Base Connection is given by,

$$I_C = \frac{\alpha}{1-\alpha} I_B + \frac{I_{CBO}}{1-\alpha}$$

- Expression for collector current in Common Emitter Connection is given by,

$$I_C = \frac{\alpha}{1-\alpha} I_B + \frac{1}{1-\alpha} I_{CBO} \quad \text{Or} \quad I_C = \frac{\alpha}{1-\alpha} I_B + I_{CEO}$$

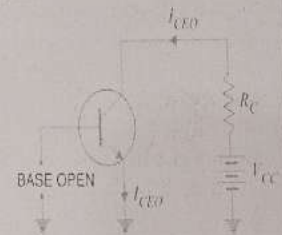

❖ **MULTI STAGE TRANSISTOR AMPLIFIER:-**

- The output from a single stage amplifier is usually insufficient to drive an output device. In other words, the gain of a single amplifier is inadequate for practical purposes.
- Consequently, additional amplification over two or three stages is necessary. To achieve this, the output of each amplifier stage is coupled in some way to the input of the next stage.
- The resulting system is referred to as multistage amplifier.
- A transistor circuit containing *more than one stage of amplification* is known as *multistage transistor amplifier*.
- In a multistage amplifier, a number of single amplifiers are connected in cascade arrangement i.e. output of first stage is connected to the input of the second stage through a suitable coupling device and so on.
- The purpose of **coupling device** (e.g. a capacitor, transformer etc.) is
 - (i) to transfer A.C. output of one stage to the input of the next stage and
 - (ii) to isolate the D.C. conditions of one stage from the next stage.
- The name of the amplifier is usually given after the type of coupling used. e.g.

Name of coupling	Name of multistage amplifier
RC coupling	R-C coupled amplifier
Transformer coupling	Transformer coupled amplifier
Direct coupling	Direct coupled amplifier

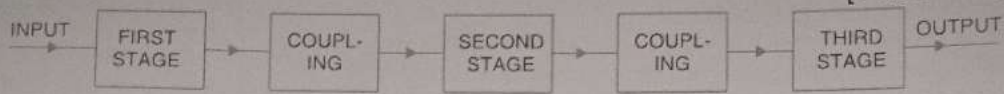

➤ **IMPORTANT TERMS:-**

- **Gain:** - The ratio of the output electrical quantity to the input one of the amplifier is called its gain.
- The gain of a multistage amplifier is equal to the product of gains of individual stages.
- **Frequency response:** - The curve between voltage gain and signal frequency of an amplifier is known as frequency response.
- **Decibel gain:** - Although the gain of an amplifier can be expressed as a number, yet great practical importance to assign it a unit.
- The unit assigned is bel or decibel (db). The common logarithm (log to the base 10) of power gain is known as bel power gain, i.e.

$$\text{power gain} = \log_{10} \frac{P_{out}}{P_{in}} \text{ bel} \quad (1 \text{ bel} = 10 \text{ db.})$$
- **Bandwidth:** - The range of frequency over which the voltage gain is equal to or greater than 70.7% of the maximum gain is known as **bandwidth**.
- From the fig. it is clear that for any frequency lying between f_1 and f_2 , the gain is equal to or greater than 70.7% of the maximum gain.
- Therefore, $f_1 - f_2$ is the bandwidth. It may be seen that f_1 and f_2 are the limiting frequencies. The f_1 is called lower cut-off frequency and f_2 is known as upper cut-off frequency.

❖ **R-C COUPLED TRANSISTOR AMPLIFIER:-**

- This is the most popular type of coupling because it is cheap and provides excellent audio fidelity over a wide range of frequency. It is usually employed for **voltage amplification**.
- Fig shows two stages of an RC coupled amplifier. A coupling capacitor C_C is used to connect the output of first stage to the base (i.e. input) of the second stage and so on.
- As the coupling from one stage to next is achieved by a coupling capacitor followed by a connection to a shunt resistor, therefore, such amplifiers are called **Resistance - Capacitance coupled amplifiers**.
- The resistances R_1, R_2 and R_E form the **biasing and stabilization network**. The emitter bypass capacitor offers **low reactance path** to the signal. Without it, the voltage gain of each stage would be lost.
- The coupling capacitor C_C transmits A.C. signal but blocks D.C. This prevents D.C. interference between various stages and the shifting of operating point.

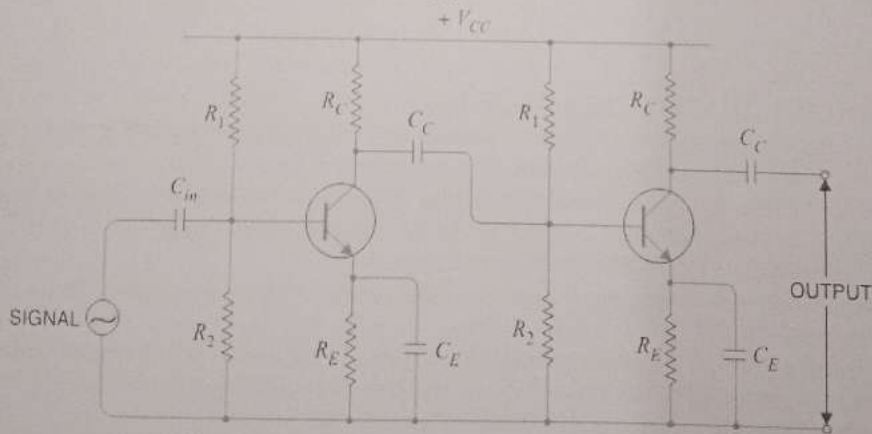

[Circuit Diagram of RC Coupled Transistor Amplifier]

➤ **OPERATION:-**

- When A.C. signal is applied to the base of the first transistor, it appears in the amplified form across its collector load R_C .
- The amplified signal developed across R_C is given to base of next stage through coupling capacitor C_C . The second stage does further amplification of the signal.

- In this way, the cascaded (one after another) stages amplify the signal and the overall gain is considerably increased.
- It may be mentioned here that total gain is less than the product of the gains of individual stages.
- It is because when a second stage is made to follow the first stage, the effective load resistance of first stage is reduced due to the shunting effect of the input resistance of second stage.
- This reduces the gain of the stage which is loaded by the next stage

✦ FREQUENCY RESPONSE R-C COUPLED TRANSISTOR AMPLIFIER:

- Fig shows the frequency response of a typical RC coupled amplifier. It is clear that voltage gain drops off at low (< 50 Hz) and high (> 20 kHz) frequencies whereas it is uniform over mid-frequency range (50 Hz to 20 kHz).

- This behaviour of the amplifier is briefly explained below:-

- (i) **At low frequencies (< 50 Hz):-** At this stage the reactance of coupling capacitor C_C is quite high and hence very small part of signal will pass from one stage to the next stage. Moreover, C_E cannot shunt the emitter resistance R_E effectively because of its large reactance at low frequencies. These two factors cause a falling of voltage gain at low frequencies.

- (ii) **At high frequencies (> 20 kHz):-** At this stage the reactance of C_C is very small and it behaves as a short circuit. This increases the loading effect of next stage and serves to reduce the voltage gain.

Moreover, at high frequency, capacitive reactance of base-emitter junction is low which increases the base current. This reduces the current amplification factor β . Due to these two reasons, the voltage gain drops off at high frequency.

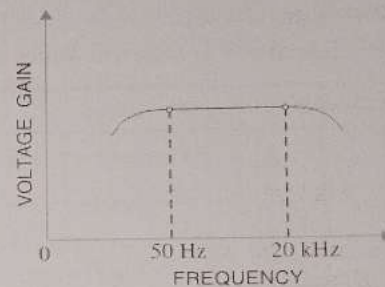

[Frequency Response Curve of RC Coupled Amp]

- (iii) **At mid-frequencies (50 Hz to 20 kHz):-** At this stage the voltage gain of the amplifier is constant. The effect of coupling capacitor in this frequency range is such so as to maintain a uniform voltage gain. Thus, as the frequency increases in this range, reactance of C_C decreases which tends to increase the gain. However, at the same time, lower reactance means higher loading of first stage and hence lower gain. These two factors almost cancel each other, resulting in a uniform gain at mid-frequency.

✦ ADVANTAGES:-

- (i) It has excellent frequency response. The gain is constant over the audio frequency range which is the region of most importance for speech, music etc.
- (ii) It has lower cost since it employs resistors and capacitors which are cheap.
- (iii) The circuit is very compact as the modern resistors and capacitors are small and extremely light.

✦ DISADVANTAGES:-

- (i) The RC coupled amplifiers have low voltage and power gain. It is because the low resistance presented by the input of each stage to the preceding stage decreases the effective load resistance (R_{AC}) and hence the gain.
- (ii) They have the tendency to become noisy with age, particularly in moist climates.
- (iii) Impedance matching is poor. It is because the output impedance of RC coupled amplifier is several hundred ohms whereas the input impedance of a speaker is only a few ohms. Hence, little power will be transferred to the speaker.

✦ APPLICATIONS:-

- The RC coupled amplifiers have excellent audio fidelity over a wide range of frequency. Therefore, they are widely used as **voltage amplifiers** e.g. in the initial stages of public address system.
- If other type of coupling (e.g. transformer coupling) is employed in the initial stages, this results in frequency distortion which may be amplified in next stages.
- However, because of poor impedance matching, RC coupling is rarely used in the final stages.

✓ CIRCUIT DIAGRAM FOR OTHER TYPE OF COUPLING ARE GIVEN BELOW:-

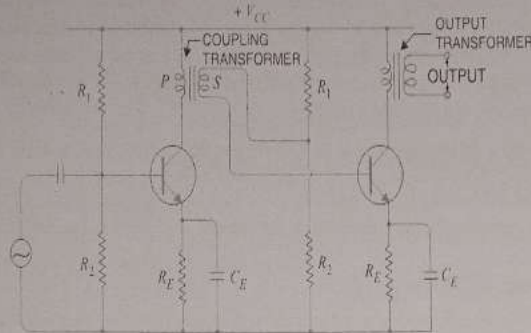

(Transformer Coupled Transistor Amplifier)

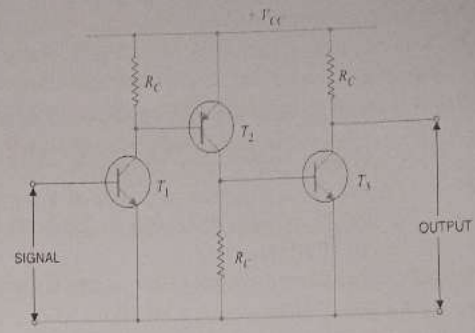

(Direct Coupled Transistor Amplifier)

➤ Comparison of Different Types of Coupling:-

S. No	Particular	RC coupling	Transformer coupling	Direct coupling
1.	Frequency response	Excellent in the audio frequency range	Poor	Best
2.	Cost	Less	More	Least
3.	Space and weight	Less	More	Least
4.	Impedance matching	Not good	Excellent	Good
5.	Use	For voltage amplification	For power amplification	For amplifying extremely low frequencies

----- [FEED BACK AMPLIFIER] -----

❖ INTRODUCTION:-

- A practical amplifier has a gain of nearly one million i.e. its output is one million times the input. Consequently, even a casual disturbance at the input will appear in the amplified form in the output.
- The noise in the output of an amplifier is undesirable and must be kept to as small a level as possible. The noise level in amplifiers can be reduced considerably by the use of negative feedback i.e. by injecting a fraction of output in phase opposition to the input signal.
- The object of this chapter is to consider the effects and methods of providing negative feedback in transistor amplifiers.

❖ FEEDBACK:-

- The process of injecting a fraction of output energy of some device back to input is known as feedback.
- Depending upon whether the feedback energy aids or opposes the input signal, there are two basic types of feedback in amplifiers viz Positive Feedback and Negative Feedback.

✦ **Positive Feedback.** When the feedback energy (voltage or current) is in phase with the input signal and thus aids it, it is called *positive feedback*. This is illustrated in Fig.

- Both amplifier and feedback network introduce a phase shift of 180°. The result is a 360° phase shift around the loop, causing the feedback voltage V_f to be in phase with the input signal V_{in} .

- The positive feedback increases the gain of the amplifier. However, it has the disadvantages of increased distortion and instability.

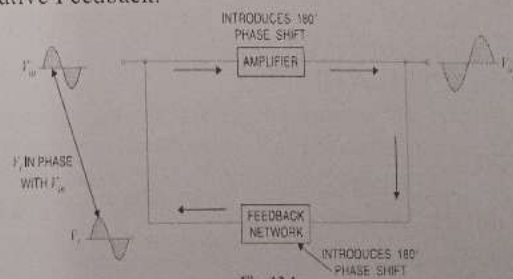

Therefore, positive feedback is not often employed in amplifiers. One important use of positive feedback is in oscillators. If positive feedback is sufficiently large, it leads to oscillations. As a matter of fact, an oscillator is a device that converts d.c. power into a.c. power of any desired frequency.

(ii) **Negative Feedback.** When the feedback energy (voltage or current) is out of phase with the input signal and thus opposes it, it is called *negative feedback*. This is illustrated in Fig.

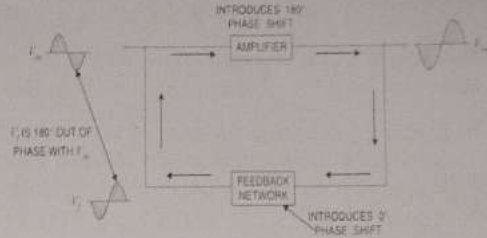

As you can see, the amplifier introduces a phase shift of 180° into the circuit while the feedback network is so designed that it introduces no phase shift (i.e., 0° phase shift). The result is that the feedback voltage V_f is 180° out of phase with the input signal V_{in} .

Negative feedback reduces the gain of the amplifier. However, the advantages of negative feedback are: reduction in distortion, stability in gain, increased bandwidth & improved input and output impedances. It is due to these advantages that negative feedback is frequently employed in amplifiers.

PRINCIPLES OF NEGATIVE VOLTAGE FEEDBACK IN AMPLIFIERS:-

A feedback amplifier has main two parts such as an amplifier and a feedback circuit.

The feedback circuit usually consists of resistors and returns a fraction of output energy back to the input.

Fig. shows the principles of negative voltage feedback in an amplifier. Typical values have been assumed to make the treatment more illustrative.

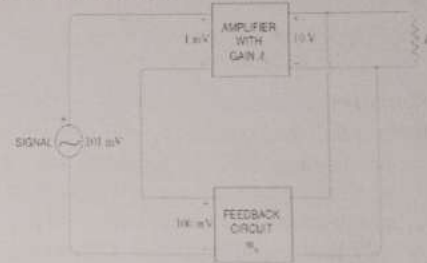

The output of the amplifier is 10 V. The fraction m_v of this output i.e. 100 mV is feedback to the input where it is applied in series with the input signal of 101 mV.

As the feedback is negative, therefore, only 1 mV appears at the input terminals of the amplifier.

Referring to Fig., we have,

- + Gain of amplifier without feedback, $A_v = (10 \text{ V}) / (1 \text{ mV}) = 10,000$
- + Fraction of output voltage feedback, $m_v = (100 \text{ mV}) / 10 \text{ V} = 0.01$
- + Gain of amplifier with negative feedback, $A_{vf} = 10 \text{ V} / 101 \text{ mV} = 100$

The following points are worth noting:-

When negative voltage feedback is applied, the gain of the amplifier is reduced. Thus, the gain of above amplifier without feedback is 10,000 whereas with negative feedback, it is only 100.

When negative voltage feedback is employed, the voltage actually applied to the amplifier is extremely small. In this case, the signal voltage is 101 mV and the negative feedback is 100 mV so that voltage applied at the input of the amplifier is only 1 mV.

In a negative voltage feedback circuit, the feedback fraction m_v is always between 0 and 1.

The gain with feedback is sometimes called **closed-loop gain** while the gain without feedback is called **open-loop gain**. These terms come from the fact that amplifier and feedback circuits form a "loop".

When loop is "opened" by disconnecting feedback circuit from I/P, amplifier's gain A_v [open-loop gain]

When the loop is "closed" by connecting the feedback circuit, gain decreases to A_{vf} ["closed-loop" gain]

GAIN OF NEGATIVE VOLTAGE FEEDBACK AMPLIFIER:-

Consider the negative voltage feedback amplifier shown in Fig.

The gain of the amplifier without feedback is A_v .

Negative feedback is then applied by feeding a fraction m_v of the output voltage e_o back to amplifier input.

Therefore, the actual input to the amplifier is the signal voltage e_g minus feedback voltage $m_v e_o$ i.e.,

$$\text{Actual input to amplifier} = (e_g - m_v e_o)$$

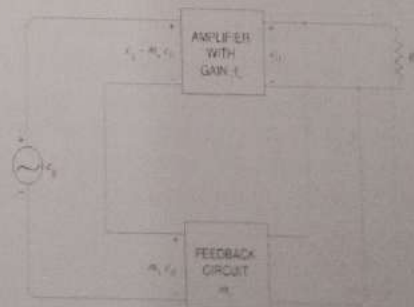

The output e_0 must be equal to the input voltage $(e_g - m_v e_0)$ multiplied by gain A_v of the amplifier

$$\begin{aligned} \text{i.e.} \quad (e_g - m_v e_0) A_v &= e_0 & \rightarrow & \quad A_v e_g - A_v m_v e_0 = e_0 \\ & \rightarrow e_0 + A_v m_v e_0 = A_v e_g & \rightarrow & \quad e_0 (1 + A_v m_v) = A_v e_g \end{aligned}$$

$$\frac{e_0}{e_g} = \frac{A_v}{1 + A_v m_v}$$

But e_0/e_g is the voltage gain of the amplifier with feedback.

\therefore Voltage gain with negative feedback is

$$A_{vf} = \frac{A_v}{1 + A_v m_v}$$

- It may be seen that the gain of the amplifier without feedback is A_v . However, when negative voltage feedback is applied, the gain is reduced by a factor $1 + A_v m_v$.
- It may be noted that negative voltage feedback does not affect the current gain of the circuit.

❖ ADVANTAGES OF NEGATIVE VOLTAGE FEEDBACK:-

- The following are the advantages of negative voltage feedback in amplifiers:-

- ❖ **Gain Stability.** An important advantage of negative voltage feedback is that the resultant gain of the amplifier can be made independent of transistor parameters or the supply voltage variations.

$$A_{vf} = \frac{A_v}{1 + A_v m_v}$$

- For negative voltage feedback in an amplifier to be effective, the designer deliberately makes the product $A_v m_v$ much greater than unity. Therefore, in the above relation, 1 can be neglected as compared to $A_v m_v$ and the expression becomes:

$$A_{vf} = \frac{A_v}{A_v m_v} = \frac{1}{m_v}$$

- It may be seen that the gain now depends only upon feedback fraction m_v i.e., on the characteristics of feedback circuit. As feedback circuit is usually a voltage divider (a resistive network), therefore, it is unaffected by changes in temperature, variations in transistor parameters and frequency. Hence, the gain of the amplifier is extremely stable.

- ❖ **(ii) Reduces non-linear Distortion.** A large signal stage has non-linear distortion because its voltage gain changes at various points in the cycle. The negative voltage feedback reduces the nonlinear distortion in large signal amplifiers.

It can be proved mathematically that:

$$D_{vf} = \frac{D}{1 + A_v m_v}$$

Where

D = distortion in amplifier without feedback

D_{vf} = distortion in amplifier with negative feedback

- Thus by applying negative voltage feedback to an amplifier, distortion is reduced by a factor $1 + A_v m_v$.
- ❖ **(iii) Improves Frequency Response.** As feedback is usually obtained through a resistive network, therefore, voltage gain of the amplifier is independent of signal frequency.
- The result is that voltage gain of the amplifier will be substantially constant over a wide range of signal frequency. The negative voltage feedback, therefore, improves the frequency response of the amplifier.
- ❖ **(iv) Increases Circuit Stability.** The output of an ordinary amplifier is easily changed due to variations in ambient temperature, frequency and signal amplitude.
- This changes the gain of the amplifier, resulting in distortion. However, by applying negative voltage feedback, voltage gain of the amplifier is stabilized or accurately fixed in value.
- This can be easily explained. Suppose the output of a negative voltage feedback amplifier has increased because of temperature change or due to some other reason.
- This means more negative feedback since feedback is being given from the output. This tends to oppose the increase in amplification and maintains it stable.
- The same is true should the output voltage decrease. Consequently, the circuit stability is considerably increased.
- ❖ **(v) Increases input impedance and decreases output impedance.** The negative voltage feedback increases the input impedance and decreases the output impedance of amplifier. Such a change is profitable in practice as the amplifier can then serve the purpose of impedance matching.

❖ **FEEDBACK CIRCUIT:-**

- The function of the feedback circuit is to return a fraction of the output voltage to the input of the amplifier.
- Fig. shows the feedback circuit of negative voltage feedback amplifier.
- It is essentially a potential divider consisting of resistances R_1 and R_2 .
- The output voltage of the amplifier is fed to this potential divider which gives the feedback voltage to the input.
- Referring to Fig. it is clear that :

Voltage across $R_1 = (\text{---}) e_0$

Feedback fraction, $m_v = \text{---} = \text{---}$

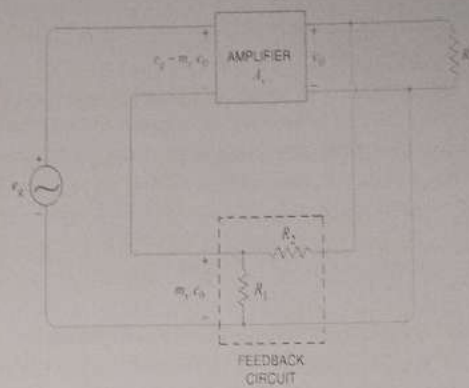

❖ **INPUT & OUTPUT IMPEDANCE OF NEGATIVE FEEDBACK AMPLIFIER :-**

- ✦ (a) **Input impedance.** The increase in input impedance with negative voltage feedback can be explained by referring to Fig.
- Suppose the input impedance of the amplifier is Z_{in} without feedback and Z'_{in} with negative feedback. Let us further assume that input current is i_1 .
- Referring to Fig., we have,

$$e_g - m_v e_0 = i_1 Z_{in}$$

Now $e_g = (e_g - m_v e_0) + m_v e_0$
 $= (e_g - m_v e_0) + A_v m_v (e_g - m_v e_0) \quad [\because e_0 = A_v (e_g - m_v e_0)]$
 $= (e_g - m_v e_0) (1 + A_v m_v)$
 $= i_1 Z_{in} (1 + A_v m_v) \quad [\because e_g - m_v e_0 = i_1 Z_{in}]$
 Or $\text{---} = Z_{in} (1 + A_v m_v)$

But $\text{---} = Z'_{in}$, the input impedance of the amplifier with negative voltage feedback.

$\therefore Z'_{in} = Z_{in} (1 + A_v m_v)$

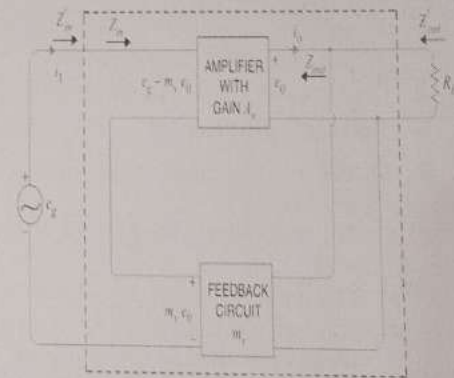

- It is clear that by applying negative voltage feedback, the input impedance of the amplifier is increased by a factor $1 + A_v m_v$. As $A_v m_v$ is much greater than unity.
- Therefore, input impedance is increased considerably. This is an advantage, since the amplifier will now present less of a load to its source circuit.
- ✦ (b) **Output impedance.** Following similar line, we can show that output impedance with negative voltage feedback is given by :

$\therefore Z'_{out} = \text{---}$

Where Z'_{out} = output impedance with negative voltage feedback
 Z_{out} = output impedance without feedback

- It is clear that by applying negative feedback, the output impedance of the amplifier is decreased by a factor $1 + A_v m_v$.
- This is an added benefit of using negative voltage feedback.
- With lower value of output impedance, the amplifier is much better suited to drive low impedance loads.

[AUDIO POWER AMPLIFIERS]

❖ INTRODUCTION:-

- A practical amplifier always consists of a number of stages that amplify a weak signal until sufficient power is available to operate a loudspeaker or other output device.
- The first few stages in this multistage amplifier have the function of only voltage amplification. However, last stage is designed to provide maximum power. This final stage is known as power stage.

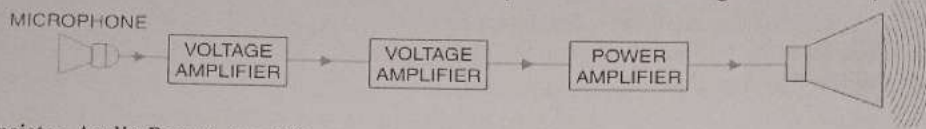

❖ Transistor Audio Power Amplifier: -

- A transistor amplifier which raises the power level of signals having audio frequency range is known as transistor **Audio Power Amplifier**. Generally last stage of a multistage amplifier is the power stage.
- The power amplifier differs from all the previous stages in that here a concentrated effort is made to obtain maximum output power.
- A transistor that is suitable for power amplification is generally called a *power transistor*.

❖ DIFFERENCE BETWEEN VOLTAGE AND POWER AMPLIFIERS

- The difference between the two types is really one of degree; it is a question of how much voltage and how much power.
- A voltage amplifier is designed to achieve maximum voltage amplification. It is, however, not important to raise the power level.
- On the other hand, a power amplifier is designed to obtain maximum output power.

1) **Voltage Amplifier.** The voltage gain of an amplifier is given by : $A_v = \beta \times \frac{R_c}{R_{in}}$

- In order to achieve high voltage amplification, the following features are incorporated in such amplifiers:
 - * The transistor with high β (>100) is used in the circuit. i.e. Transistors are employed having thin base.
 - * The input resistance R_{in} of transistor is sought to be quite low as compared to the collector load R_c .
 - * A relatively high load R_c is used in the collector. To permit this condition, voltage amplifiers are always operated at low collector currents (\approx mA). If the collector current is small, we can use large R_c in the collector circuit

2) **Power Amplifier.** A power amplifier is required to deliver a large amount of power and as such it has to handle large current.

- In order to achieve high power amplification, the following features are incorporated in such amplifiers:
 - * The size of power transistor is made considerably larger in order to dissipate the heat produced in the transistor during operation.
 - * The base is made thicker to handle large currents. In other words, transistors with comparatively smaller β are used.
 - * Transformer coupling is used for impedance matching.

The comparison between voltage and power amplifiers is given below in the tabular form :

S. No.	Particular	Voltage amplifier	Power amplifier
1.	β	High (> 100)	low (5 to 20)
2.	R_c	High (4 – 10 k Ω)	low (5 to 20 Ω)
3.	Coupling	usually R – C coupling	Invariably transformer coupling
4.	Input voltage	low (a few mV)	High (2 – 4 V)
5.	Collector current	low (\approx 1 mA)	High (> 100 mA)
6.	Power output	low	high
7.	Output impedance	High (\approx 12 k Ω)	low (200 Ω)

❖ **PERFORMANCE QUANTITIES OF POWER AMPLIFIERS**

➤ The prime objective for a power amplifier is to obtain maximum output power. Since a transistor, like any other electronic device has voltage, current and power dissipation limits, therefore, the criteria for a power amplifier are : **Collector Efficiency, Distortion & Power Dissipation Capability**

➤ **Collector efficiency.**

➤ The main criterion for a power amplifier is not the power gain rather it is the maximum a.c. power output. Now, an amplifier converts d.c. power from supply into a.c. power output.

➤ Therefore, the ability of a power amplifier to convert d.c. power from supply into a.c. output power is a measure of its effectiveness. This is known as *collector efficiency* and may be defined as under :

➤ The ratio of a.c. output power to the zero signal power (i.e. d.c. power) supplied by the battery of a power amplifier is known as **collector efficiency**.

➤ **Distortion.** The change of output wave shape from input wave shape of amplifier is called **Distortion**.

➤ **Power Dissipation Capability.** The ability of a power transistor to dissipate heat is known as power dissipation capability.

❖ **CLASSIFICATION OF POWER AMPLIFIERS**

➤ Transistor power amplifiers handle large signals. Many of them are driven by the input large signal that collector current is either cut-off or is in the saturation region during a large portion of the input cycle.

➤ Therefore, such amplifiers are generally classified according to their mode of operation i.e. the portion of the input cycle during which the collector current is expected to flow. On this basis, they are classified as

- (i) Class A power amplifier (ii) Class B power amplifier (iii) Class C power amplifier

➤ **CLASS A POWER AMPLIFIER.** If the collector current flows at all times during the full cycle of the signal, the power amplifier is known as *class A power amplifier*.

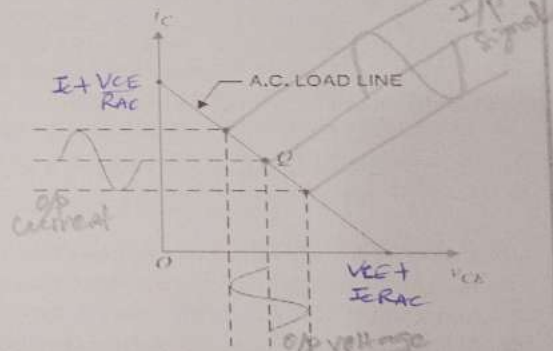
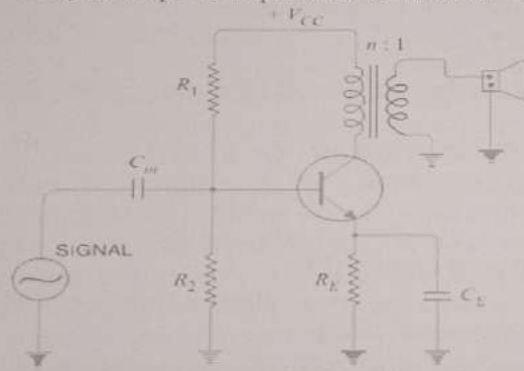

➤ The power amplifier must be biased in such a way that no part of the signal is cut off. Fig (i) shows circuit of class A power amplifier. Note that collector has a transformer as the load which is most common for all classes of power amplifiers.

➤ The use of transformer permits impedance matching, resulting in the transference of maximum power to the load e.g. loudspeaker. Fig (ii) shows the class A operation in terms of a.c. load line.

➤ The operating point Q is so selected that collector current flows at all times throughout the full cycle of the applied signal. As the output wave shape is exactly similar to the input wave shape, therefore, such amplifiers have least distortion.

➤ However, they have the disadvantage of low power output and low collector efficiency (about 35%).

➤ **CLASS B POWER AMPLIFIER:** - If the collector current flows only during the positive half-cycle of the input signal, it is called a *class B power amplifier*.

➤ In class B operation, the transistor bias is so adjusted that zero signal collector current is zero i.e. no biasing circuit is needed at all.

➤ During the positive half-cycle of the signal, the input circuit is forward biased and hence collector current flows. However, during the negative half-cycle of the signal, the input circuit is reverse biased and no collector current flows.

- Fig. shows the class B operation in terms of a.c. load line.
- The operating point Q shall be located at collector cut off voltage.
- It is easy to see that output from a class B amplifier is amplified half-wave rectification.
- In a class B amplifier, the negative half-cycle of the signal is cut off and hence a severe distortion occurs.
- However, class B amplifiers provide higher power output and collector efficiency (50 - 60%).
- Such amplifiers are mostly used for power amplification in push-pull arrangement.
- In such an arrangement, 2 transistors are used in class B operation. One transistor amplifies the positive half cycle of the signal while the other amplifies the negative half-cycle.

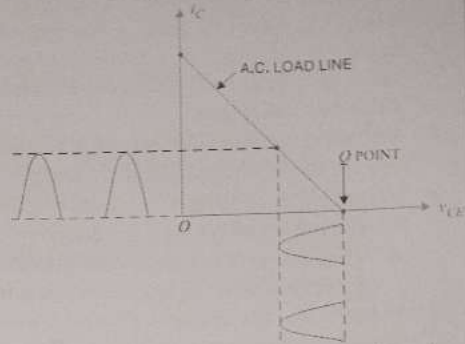

- **CLASS C POWER AMPLIFIER.** If the collector current flows for less than half-cycle of the input signal, it is called *class C power amplifier*.
- In class C amplifier, the base is given some negative bias so that collector current does not flow just when the positive half-cycle of the signal starts.
- Such amplifiers are never used for power amplification. However, they are used as tuned amplifiers i.e. to amplify a narrow band of frequencies near the resonant frequency.

➤ **EXPRESSION FOR COLLECTOR EFFICIENCY**

- For comparing power amplifiers, collector efficiency is the main criterion. The greater the collector efficiency, the better is the power amplifier.

➤ Now, Collector Efficiency, $\eta = \frac{\text{a.c. power output}}{\text{d.c. power input}} = \frac{P_o}{P_{dc}}$

- Where $P_{dc} = V_{CC} I_C$ & $P_o = V_{CE} I_C$ in which V_{CE} is the r.m.s. value of signal output voltage and I_C is the r.m.s. value of output signal current.

- In terms of peak-to-peak values, the a.c. power output can be expressed as:

$$P_o = [(0.5 \times 0.707) V_{ce(p-p)}][(0.5 \times 0.707) i_{c(p-p)}] = \frac{V_{ce(p-p)} \times I_{c(p-p)}}{8}$$

$$\therefore \text{Collector } \eta = \frac{V_{ce(p-p)} \times I_{c(p-p)}}{8 V_{CC} I_C}$$

➤ **IMPORTANT POINTS ABOUT CLASS-A POWER AMPLIFIER :-**

- (i) A Transformer coupled class A power amplifier has a maximum collector efficiency of 50% i.e., maximum of 50% d.c. supply power is converted into a.c. power output.
- In practice, the efficiency of such an amplifier is less than 50% (about 35%) due to power losses in the output transformer, power dissipation in the transistor etc.
- (ii) The power dissipated by a transistor is given by :

$$P_{dis} = P_{dc} - P_{ac}$$

Where P_{dc} = available d.c. power

& P_{ac} = available a.c. power

- So, In class A operation, Transistor must dissipate less heat when signal is applied therefore runs cooler.
- (iii) When no signal is applied to a class A power amplifier, $P_{ac} = 0$. $\therefore P_{dis} = P_{dc}$
- Thus in class A operation, maximum power dissipation in the transistor occurs under zero signal conditions.
- Therefore, the power dissipation capability of a power transistor (for class A operation) must be at least equal to the zero signal rating.
- (iv) When a class A power amplifier used in final stage, it is called single ended class A power amplifier.

↓ PUSH-PULL AMPLIFIER :-

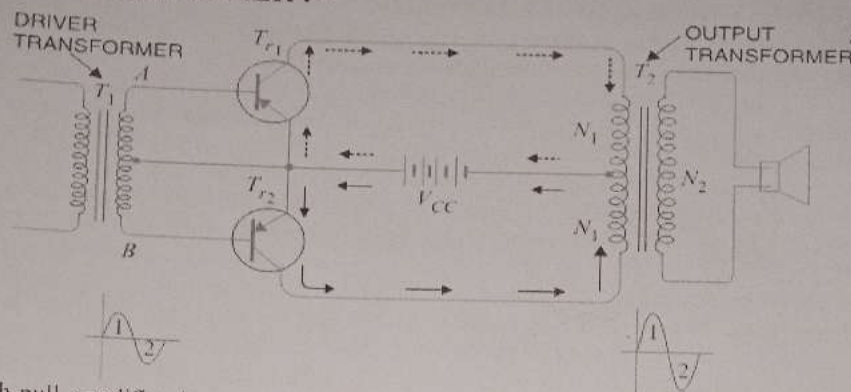

- The push-pull amplifier is a power amplifier and is frequently employed in the output stages of electronic circuits. It is used whenever high output power at high efficiency is required. Fig. shows the circuit of a push-pull amplifier.
- Two transistors T_{r1} and T_{r2} placed back to back are employed. Both transistors are operated in class B operation i.e. collector current is nearly zero in the absence of the signal.
- The centre tapped secondary of driver transformer T_1 supplies equal and opposite voltages to the base circuits of two transistors. The output transformer T_2 has the centre-tapped primary winding. The supply voltage V_{CC} is connected between the bases and this centre tap.
- The loudspeaker is connected across the secondary of this transformer.

± CIRCUIT OPERATION.

- The input signal appears across the secondary AB of driver transformer. Suppose during the first half-cycle (marked 1) of the signal, end A becomes positive and end B negative.
- This will make the base-emitter junction of T_{r1} reverse biased and that of T_{r2} forward biased. The circuit will conduct current due to T_{r2} only and is shown by solid arrows.
- Therefore, this half-cycle of the signal is amplified by T_{r2} and appears in the lower half of the primary of output transformer. In the next half cycle of the signal, T_{r1} is forward biased whereas T_{r2} is reverse biased. Therefore, T_{r1} conducts and is shown by dotted arrows.
- Consequently, this half-cycle of the signal is amplified by T_{r1} and appears in the upper half of the output transformer primary. The centre-tapped primary of the output transformer combines two collector currents to form a sine wave output in the secondary.
- It may be noted here that push-pull arrangement also permits a maximum transfer of power to the Load through impedance matching. If R_L is the resistance appearing across secondary of output transformer, then resistance R'_L of primary shall become:

$$R'_L = \left(\frac{2N_1}{N_2}\right)^2 R_L$$

Where N_1 = Number of turns between either end of primary winding and centre-tap
 N_2 = Number of secondary turns

± ADVANTAGES

- 1) The efficiency of the circuit is quite high ($\approx 75\%$) due to class B operation.
- 2) A high a.c. output power is obtained.

± DISADVANTAGES

- 1) Two transistors have to be used.
- 2) It requires two equal and opposite voltages at the input. Therefore, push-pull circuit requires the use of driver stage to furnish these signals.
- 3) If the parameters of the two transistors are not the same, there will be unequal amplification of the two halves of the signal.
- 4) The circuit gives more distortion.
- 5) Transformers used are bulky and expensive.

† COMPLEMENTARY-SYMMETRY AMPLIFIER

- By complementary symmetry is meant a principle of assembling push-pull class B amplifier without requiring centre-tapped transformers at the input and output stages.

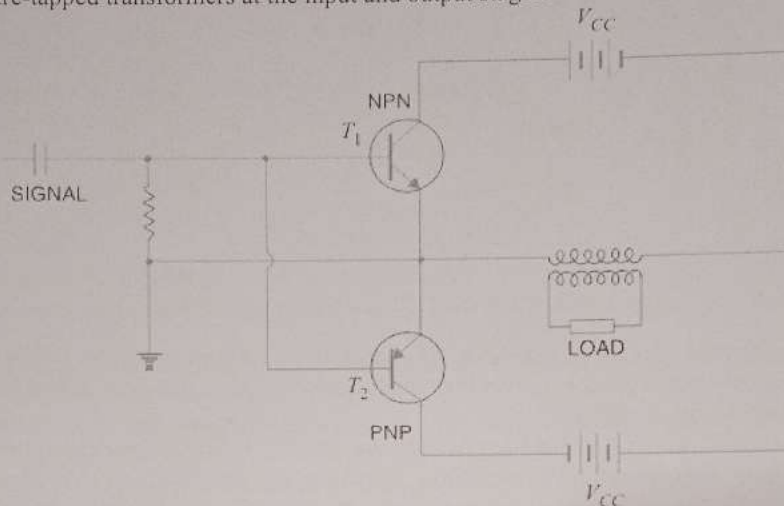

- Fig. shows the transistor push-pull amplifier using complementary symmetry. It employs one npn and one pnp transistor and requires no centre-tapped transformers.
- The circuit action is as follows. During the positive-half of the input signal, transistor T_1 (the npn transistor) conducts current while T_2 (the pnp transistor) is cutoff.
- During the negative half-cycle of the signal, T_2 conducts while T_1 is cut off. In this way, npn transistor amplifies the positive half-cycles of the signal while the pnp transistor amplifies the negative half-cycles of the signal.

- Note that we generally use an output transformer (not centre-tapped) for impedance matching.

† **Advantages:** - (1) This circuit does not require transformer. This saves on weight and cost.

(2) Equal and opposite input signal voltages are not required.

† **Disadvantages:** - (1) It is difficult to get a pair of transistors (nnp & pnp) having similar characteristics.

(2) We require both positive and negative supply voltages.

† **HEAT SINK:** -

- As power transistors handle large currents, they always heat up during operation. Since transistor is a temperature dependent device, the heat must be dissipated to the surroundings to keep the temperature within allowed limits.
- Usually transistor is fixed on Aluminum metal sheet so that additional heat is transferred to the Al sheet.
- The metal sheet that serves to dissipate the additional heat from power transistor is known as Heat Sink.

---P N GOUDA--- THE BEST --- P N GOUDA ---

[SINUSOIDAL OSCILLATOR]

❖ INTRODUCTION TO OSCILLATOR: -

- Many electronic devices require a source of energy at a specific frequency which may range from a few Hz to several MHz. This is achieved by an electronic device called an oscillator.
- Oscillators are extensively used in electronic equipment. For example, in radio and television receivers, oscillators are used to generate high frequency wave (called carrier wave) in the tuning stages.
- Audio frequency and radiofrequency signals are required for the repair of radio, television and other electronic equipment. Oscillators are also widely used in radar, electronic computers and other electronic devices. Oscillators can produce sinusoidal or non-sinusoidal (e.g. square wave) waves.

❖ SINUSOIDAL OSCILLATORS:-

- An electronic device that generates sinusoidal oscillations of desired frequency is known as a **sinusoidal oscillator**. Although we speak of an oscillator as "generating" a frequency, it should be noted that it does not create energy, but merely acts as an energy converter.
- It receives D.C. energy and changes it into A.C. energy of our desired frequency.
- The frequency of oscillations depends upon the constants of the device. It may be mentioned here that although an alternator produces sinusoidal oscillations of 50Hz, it cannot be called an oscillator.
- **Firstly**, An alternator is a mechanical device having rotating parts whereas an oscillator is a non-rotating electronic device.
- **Secondly**, An alternator converts Mechanical Energy into A.C. Energy while an oscillator converts D.C. Energy into A.C. energy.
- **Thirdly**, An alternator cannot produce high frequency oscillations whereas an oscillator can produce oscillations ranging from a few Hz to several MHz.

❖ ADVANTAGES

- Although oscillations can be produced by mechanical devices (e.g. alternators), but electronic oscillators have the following advantages:
 - ♣ An oscillator is a non-rotating device. Consequently, there is little wear and tear and hence longer life.
 - ♣ Due to the absence of moving parts, the operation of an oscillator is quite silent.
 - ♣ An oscillator can produce waves from small (20 Hz) to extremely high frequencies (> 100 MHz).
 - ♣ The frequency of oscillations can be easily changed when desired.
 - ♣ It has good frequency stability i.e. frequency once set remains constant for considerable period of time.
 - ♣ It has very high efficiency.

❖ TYPES OF SINUSOIDAL OSCILLATIONS:-

- Sinusoidal oscillations can be of two types viz **Damped Oscillations** and **Undamped Oscillations**.
 - ♣ **(i) Damped Oscillations:** - The electrical oscillations whose amplitude goes on decreasing with time are called damped oscillations. Fig (i) Shows waveform of damped electrical oscillations.
 - Obviously, the electrical system in which these oscillations are generated has losses and some energy is lost during each oscillation.
 - Further, no means are provided to compensate for the losses and consequently the amplitude of the generated wave decreases gradually. It may be noted that frequency of oscillations remains unchanged since it depends upon the constants of the electrical system.
 - ♣ **(ii) Undamped Oscillations.** The electrical oscillations whose amplitude remains constant with time are called undamped oscillations. Fig. (ii) Shows waveform of undamped electrical oscillations.
 - Although the electrical system in which these oscillations are being generated has also losses, but now right amount of energy is being supplied to overcome the losses.
 - Consequently, amplitude of generated wave remains constant. It should be emphasized that an oscillator is required to produce undamped electrical oscillations for utilizing in various electronics equipment.

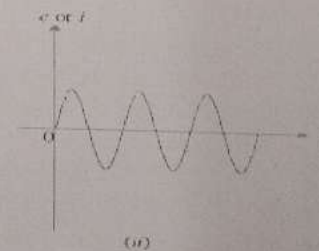
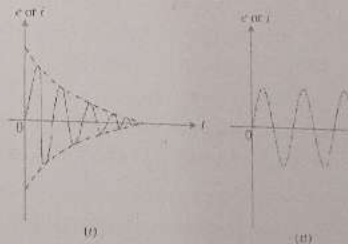

❖ **OSCILLATORY CIRCUIT: -**

- A circuit which produces electrical oscillations of any desired frequency is known as an **Oscillatory Circuit** or **Tank Circuit**.
- A simple oscillatory circuit consists of a capacitor (C) and inductance coil (L) in parallel as shown in Fig. This system can produce electrical oscillations of frequency determined by the values of L and C.
- To understand how this comes about, suppose the capacitor is charged from a d.c. source with a polarity as shown in Fig. (i).

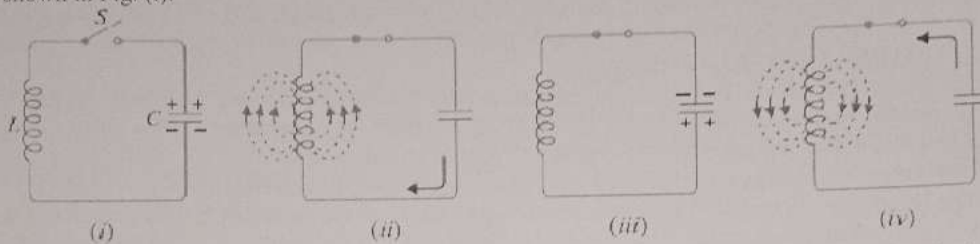

- (i) In the position shown in Fig (i), the upper plate of capacitor has deficit of electrons and the lower plate has excess of electrons. Therefore, there is a voltage across the capacitor and the capacitor has electrostatic energy.
- (ii) When switch S is closed as shown in Fig (ii), the capacitor will discharge through inductance and the electron flow will be in the direction indicated by the arrow.
- This current flow sets up magnetic field around the coil. Due to the inductive effect, the current builds up slowly towards a maximum value.
- The circuit current will be maximum when the capacitor is fully discharged. At this instant, electrostatic energy is zero but because electron motion is greatest (i.e. maximum current), the magnetic field energy around the coil is maximum. This is shown in Fig (ii).
- Obviously, the electrostatic energy across the capacitor is completely converted into magnetic field energy around the coil.
- (iii) Once the capacitor is discharged, the magnetic field will begin to collapse and produce a counter e.m.f. According to Lenz's law, the counter e.m.f. will keep the current flowing in the same direction.
- The result is that the capacitor is now charged with opposite polarity, making upper plate of capacitor negative and lower plate positive as shown in Fig (iii).
- (iv) After the collapsing field has recharged the capacitor, the capacitor now begins to discharge; current now flowing in the opposite direction.
- Fig (iv) shows capacitor fully discharged and maximum current flowing. The sequence of charge and discharge results in alternating motion of electrons or an oscillating current.
- The energy is alternately stored in the electric field of the capacitor (C) and the magnetic field of the inductance coil (L). This interchange of energy between L and C is repeated over and over again resulting in the production of oscillations.

❖ **UNDAMPED OSCILLATIONS FROM TANK CIRCUIT:-**

- As discussed before, a tank circuit produces damped oscillations. However, in practice, we need continuous undamped oscillations for the successful operation of electronics equipment.
- In order to make the oscillations in the tank circuit undamped, it is necessary to supply correct amount of energy to tank circuit at proper time intervals to meet the losses.
- Therefore, in order to make the oscillations in the tank circuit undamped, the following conditions must be fulfilled :
 - ♣ (i) The amount of energy supplied should be such so as to meet the losses in the tank circuit & the a.c. energy removed from the circuit by the load.
 - ♣ (ii) The applied energy should have the same frequency as tank circuit.
 - ♣ (iii) The applied energy should be in phase with the oscillations set up in the tank circuit.
- If these conditions are fulfilled, the circuit will produce continuous undamped output as shown in Fig.

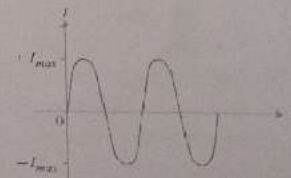

Therefore, the amplifier will produce sinusoidal output with no external signal source. The following points may be noted carefully :

- * A transistor amplifier with proper positive feedback will work as an oscillator.
- * The circuit needs only a quick trigger signal to start the oscillations.
- * Once the oscillations have started, no external signal source is needed.
- * In order to get continuous undamped output from the circuit, the following condition must be met:

$$m_v A_v = 1$$

Where A_v = Voltage Gain of Amplifier without Feedback and m_v = Feedback Fraction

* This relation is called **Barkhausen Criterion**.

❖ ESSENTIALS OF TRANSISTOR OSCILLATOR: -

Fig shows the block diagram of an oscillator. Its essential components are : -

* **Tank circuit.** It consists of inductance coil (L) connected in parallel with capacitor (C).

✎ The frequency of oscillations circuit depend upon the values of inductance of the coil and capacitance of the capacitor.

* (ii) **Transistor Amplifier.** The transistor amplifier receives D.C. power from the battery and changes it into a.c. power for supplying to the tank circuit.

✎ The oscillations occurring in the tank circuit are applied to the input of the transistor amplifier. Because of the amplifying properties of the transistor, we get increased output of these oscillations.

✎ This amplified output of oscillations is due to the D.C. power supplied by the battery.

✎ The output of the transistor can be supplied to the tank circuit to meet the losses.

* (iii) **Feedback Circuit.** The feedback circuit supplies a part of collector energy to the tank circuit in correct phase to aid the oscillations i.e. it provides positive feedback.

❖ DIFFERENT TYPES OF TRANSISTOR OSCILLATORS:-

✎ A transistor can work as an oscillator to produce continuous undamped oscillations of any desired frequency if tank and feedback circuits are properly connected to it.

✎ All oscillators under different names have similar function i.e., they produce continuous undamped output. However, the major difference between these oscillators lies in the method by which energy is supplied to the tank circuit to meet the losses.

✎ The following are the transistor oscillators commonly used at various places in electronic circuits:

- (i) Tuned Collector Oscillator
- (ii) Colpitt's Oscillator
- (iii) Hartley Oscillator
- (iv) Phase Shift Oscillator
- (v) Wien Bridge Oscillator
- (vi) Crystal Oscillator

❖ TUNED COLLECTOR OSCILLATOR:-

✎ Fig shows circuit of tuned collector oscillator. It contains tuned circuit $L_1 - C_1$ in the collector and hence the name.

✎ The frequency of oscillations depends upon the values of L_1 and C_1 and is given by :

$$f = \frac{1}{2\pi\sqrt{L_1 C_1}}$$

✎ The feedback coil L_2 in the base circuit is magnetically coupled to the tank circuit coil L_1 . In practice, L_1 and L_2 form the primary and secondary of the transformer respectively.

✎ The biasing is provided by potential divider arrangement. The capacitor C connected in the base circuit provides low reactance path to the oscillations.

* **Circuit Operation.** When switch S is closed, collector current starts increasing and charges the capacitor C_1 . When this capacitor is fully charged, it discharges through coil L_1 , setting up oscillations of frequency determined by above equation.

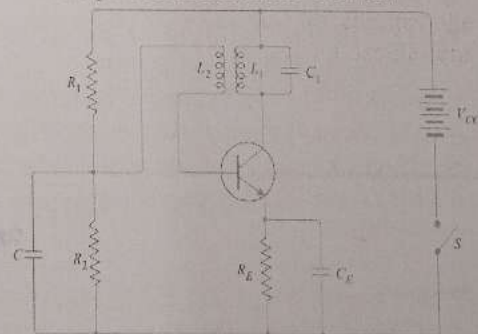
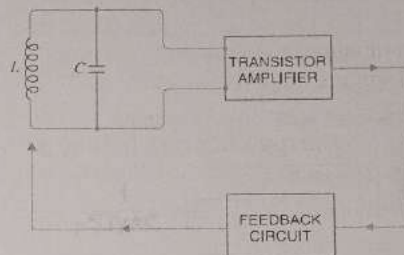

- These oscillations induce some voltage in coil L_2 by mutual induction. The frequency of voltage in coil L_2 is the same as that of tank circuit but its magnitude depends upon the number of turns of L_2 and coupling between L_1 and L_2 .
- The voltage across L_2 is applied between base and emitter and appears in the amplified form in the collector circuit, thus overcoming the losses occurring in the tank circuit.
- The number of turns of L_2 and coupling between L_1 and L_2 are so adjusted that oscillations across L_2 are amplified to a level just sufficient to supply losses to the tank circuit.
- It may be noted that the phase of feedback is correct i.e. energy supplied to the tank circuit is in phase with the generated oscillations. A phase shift of 180° is created between the voltages of L_1 and L_2 due to transformer action.
- A further phase shift of 180° takes place between base-emitter and collector circuit due to transistor properties. As a result, the energy feedback to the tank circuit is in phase with the generated oscillations.

❖ **COLPITT'S OSCILLATOR:-**

- Fig shows a Colpitt's oscillator. It uses two capacitors and placed across a common inductor L and the centre of the two capacitors is tapped.
- The tank circuit is made up of C_1 , C_2 and L . The frequency of oscillations is determined by the values of C_1 , C_2 and L and is given by ;

$$f = \frac{1}{2\pi\sqrt{L C_T}} \quad \text{Where } C_T = \frac{C_1 C_2}{C_1 + C_2}$$

★ Note that $C_1 - C_2 - L$ is also the feedback circuit that produces a phase shift of 180° .

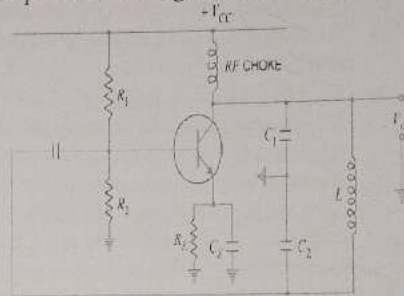

- Circuit Operation.** When the circuit is turned on, the capacitors C_1 and C_2 are charged. The capacitors discharge through L , setting up oscillations of frequency determined by exp.(i).
- Output voltage of the amplifier appears across C_1 and feedback voltage is developed across C_2 . The voltage across it is 180° out of phase with the voltage developed across C_1 (V_{out}) as shown in Fig.
- It is easy to see that voltage feedback (voltage across C_2) to the transistor provides positive feedback.
- A phase shift of 180° is produced by transistor and a further phase shift of 180° is produced by $C_1 - C_2$ voltage divider. In this way, feedback is properly phased to produce continuous undamped oscillation.

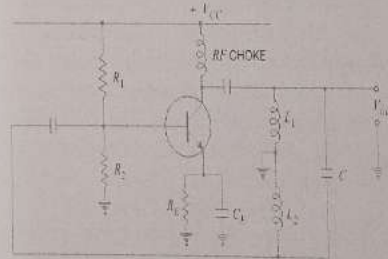

❖ **HARTLEY OSCILLATOR:-**

- The Hartley oscillator is similar to Colpitt's oscillator with minor modifications. Instead of using tapped capacitors, two inductors L_1 and L_2 are placed across a common capacitor C and the centre of the inductors is tapped as shown in Fig.
- The tank circuit is made up of L_1 , L_2 and C . The frequency of oscillations is determined by the values of L_1 , L_2 and C and is given by :

$$f = \frac{1}{2\pi\sqrt{(L_1 + L_2 + 2M)C}} \dots \dots (i)$$

Where $L_T = L_1 + L_2 + 2M$ & $M =$ Mutual inductance between L_1 & L_2

- Circuit Operation.** When the circuit is turned on, the capacitor is charged. When this capacitor is fully charged, it discharges through coils L_1 and L_2 setting up oscillations of frequency determined by equ (i).
- The output voltage of the amplifier appears across L_1 and feedback voltage across L_2 . The voltage across L_2 is 180° out of phase with the voltage developed across L_1 (V_{out}) as shown in Fig.
- It is easy to see that voltage feedback (i.e., voltage across L_2) to transistor provides positive feedback.
- A phase shift of 180° is produced by the transistor & further phase shift of 180° is produced by $L_1 - L_2$ voltage divider. In this way, feedback is properly phased to produce continuous undamped oscillations.

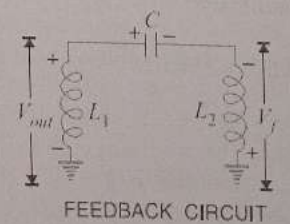

❖ **PRINCIPLE OF PHASE SHIFT OSCILLATORS:-**

- ✎ One desirable feature of an oscillator is that it should feedback energy of correct phase to the tank circuit to overcome the losses occurring in it.
- ✎ In the oscillator circuits discussed so far, the tank circuit employed inductive (L) and capacitive (C) elements. In such circuits, a phase shift of 180° was obtained due to inductive or capacitive coupling and a further phase shift of 180° was obtained due to transistor properties.
- ✎ In this way, energy supplied to the tank circuit was in phase with the generated oscillations. The oscillator circuits employing L-C elements have two general drawbacks.
- ✎ **Firstly**, they suffer from frequency instability and poor waveform. **Secondly**, they cannot be used for very low frequencies because they become too much bulky and expensive.
- ✎ Good frequency stability and waveform can be obtained from oscillators employing resistive and capacitive elements. Such amplifiers are called R-C or phase shift oscillators and have the additional advantage that they can be used for very low frequencies.
- ✎ In a phase shift oscillator, a phase shift of 180° is obtained with a phase shift circuit instead of inductive or capacitive coupling.
- ✎ A further phase shift of 180° is introduced due to the transistor properties. Thus, energy supplied back to the tank circuit is assured of correct phase.

✎ **Phase shift Circuit.** A phase-shift circuit essentially consists of an R-C network. Fig (i) shows a single section of RC network. From the elementary theory of electrical engineering, it can be shown that alternating voltage V₁ across R leads the applied voltage V₁ by φ°. The value of φ depends upon the values of R and C.

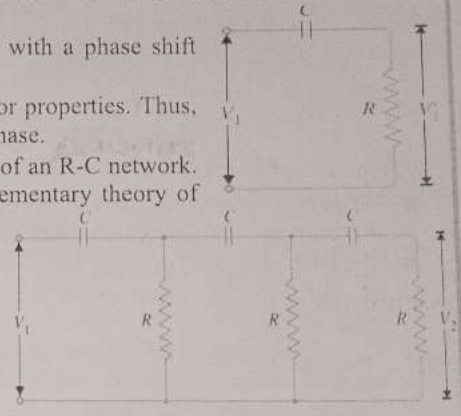

- ✎ If resistance R is varied, the value of φ also changes. If R were reduced to zero, V₁' will lead V₁ by 90° i.e. φ = 90°.
- ✎ However, adjusting R to zero would be impracticable because it would lead to no voltage across R.
- ✎ Therefore, in practice, R is varied to such a value that makes V₁' to lead V₁ by 60°.
- ✎ Fig (ii) shows the three sections of RC network. Each section produces a phase shift of 60°. Consequently, a total phase shift of 180° is produced i.e. voltage V₂ leads the voltage V₁ by 180°.

❖ **PHASE SHIFT OSCILLATOR:-**

- ✎ Fig. shows the circuit of a phase shift oscillator. It consists of a conventional single transistor amplifier and a RC phase shift network.
- ✎ The phase shift network consists of three sections R₁C₁, R₂C₂ and R₃C₃. At some particular frequency f₀, the phase shift in each RC section is 60° so that total phase-shift produced by the RC network is 180°.
- ✎ The frequency of oscillations is given by:

$$f_0 = \frac{1}{2\pi RC\sqrt{6}} \quad \text{Where } R_1=R_2=R_3=R \text{ \& } C_1=C_2=C_3=C$$

✎ **Circuit Operation.** When the circuit is switched on, it produces oscillations of frequency determined by exp. (i). The output E₀ of the amplifier is fed back to RC feedback network.

- ✎ This network produces a phase shift of 180° and a voltage E₁ appears at its output which is applied to the transistor amplifier.
- ✎ Obviously, the feedback fraction m = E₁/E₀. The feedback phase is correct. A phase shift of 180° is produced by the transistor amplifier.
- ✎ A further phase shift of 180° is produced by the RC network. As a result, the phase shift around the entire loop is 360°.

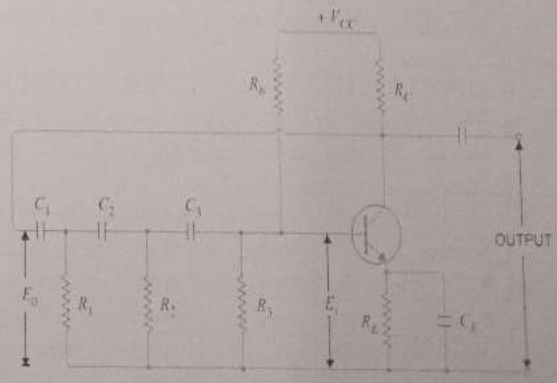

✎ **Advantages**

- ✎ It does not require transformers or inductors.
- ✎ It can be used to produce very low frequencies.
- ✎ The circuit provides good frequency stability.

✦ **Disadvantages**

- ✦ It is difficult for the circuit to start oscillations as the feedback is generally small.
- ✦ The circuit gives small output.

❖ **WIEN BRIDGE OSCILLATOR:-**

- ✦ The Wien-bridge oscillator is the standard oscillator circuit for all frequencies in the range of 10 Hz to about 1 MHz. It is the most frequently used type of audio oscillator as the output is free from circuit fluctuations and ambient temperature.
- ✦ Fig. shows the circuit of Wien bridge oscillator. It is essentially a two-stage amplifier with R-C bridge circuit. The bridge circuit has the arms R_1C_1 , R_3 , R_2C_2 and tungsten lamp L_p .
- ✦ Resistances R_3 and L_p are used to stabilize the amplitude of the output. The transistor T_1 serves as an oscillator and amplifier while the other transistor T_2 serves as an inverter (to produce 180° phase shift).
- ✦ The circuit uses positive and negative feedbacks. The positive feedback is through R_1C_1 , C_2R_2 to the transistor T_1 . The negative feedback is through the voltage divider to the input of transistor T_2 .
- ✦ The frequency of oscillations is determined by the series element R_1C_1 and parallel element R_2C_2 of the bridge.

$$f = \frac{1}{2\pi R_1 C_1 R_2 C_2} \quad \cdot \quad \text{If } R_1 = R_2 = R \text{ and } C_1 = C_2 = C, \text{ then, } f = \frac{1}{2\pi RC}$$

- ✦ When the circuit is started, bridge circuit produces oscillations of frequency determined.
- ✦ The two transistors produce a total phase shift of 360° so that proper positive feedback is ensured.
- ✦ The negative feedback in the circuit ensures constant output. This is achieved by the temperature sensitive tungsten lamp L_p . Its resistance increases with current.
- ✦ Should the amplitude of output tend to increase, more current would provide more negative feedback.
- ✦ The result is that the output would return to original value.
- ✦ A reverse action would take place if the output tends to decrease.

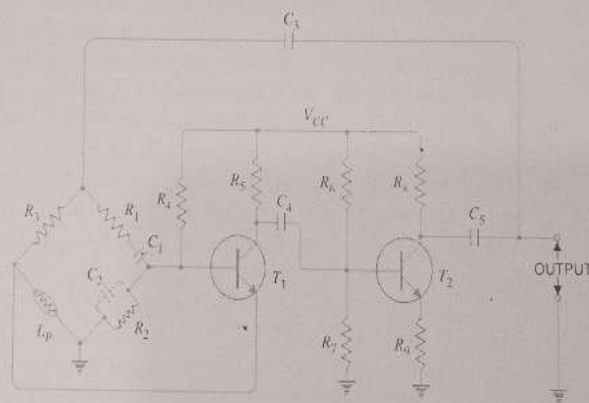

✦ **Advantages**

- (i) It gives constant output.
- (ii) It works quite easily.
- (iii) Overall gain is high due to two transistors.
- (iv) The frequency of oscillations can be easily changed by using a potentiometer.

✦ **Disadvantages**

- (v) It requires two transistors & large number of components.
- (vi) It cannot generate very high frequencies.

❖ **LIMITATIONS OF LC AND RC OSCILLATORS:-**

- ✦ The LC and RC oscillators discussed so far have their own limitations. The major problem in such circuits is that their operating frequency does not remain strictly constant. There are two principal reasons for it viz.,
 - ✦ (i) As the circuit operates, it will warm up. Consequently, the values of resistors and inductors, which are the frequency determining factors in these circuits, will change with temperature.
 - ✦ This causes the change in frequency of the oscillator.
 - ✦ (ii) If any component in the feedback network is changed, it will shift the operating frequency of the oscillator. However, in many applications, it is desirable and necessary to maintain the frequency constant with extreme low tolerances.

- ✦ It is apparent that if we employ LC or RC circuits, a change of temperature may cause the frequencies of adjacent broadcasting stations to overlap.
- ✦ In order to maintain constant frequency, piezoelectric crystals are used in place of LC or RC circuits. Oscillators of this type are called crystal oscillators.
- ✦ The frequency of a crystal oscillator changes by less than 0.1% due to temperature and other changes.
- ✦ Therefore, such oscillators offer the most satisfactory method of stabilizing the frequency and are used in great majority of electronic applications.

❖ **PIEZOELECTRIC CRYSTALS:-**

- ✦ Certain crystalline materials, namely, *Rochelle salt, quartz and tourmaline* exhibit the **piezoelectric effect** i.e., when we apply an a.c. voltage across them, they vibrate at the frequency of the applied voltage. Conversely, when they are compressed or placed under mechanical strain to vibrate, they produce an a.c. voltage.
- ✦ Such crystals which exhibit piezoelectric effect are called **piezoelectric crystals**. Of the various piezoelectric crystals, **quartz** is most commonly used as it is inexpensive & readily available in nature.
- ✦ **Quartz Crystal.** Quartz crystals are generally used in crystal oscillators because of their great mechanical strength and simplicity of manufacture.
- ✦ The natural shape of quartz crystal is hexagonal as shown in Fig. The three axes are shown: the z-axis is called the optical axis, the x-axis is called the electrical axis and y-axis is called the mechanical axis.
- ✦ Quartz crystal can be cut in different ways. Crystal cut perpendicular to the x-axis is called **x-cut crystal** whereas that cut perpendicular to y-axis is called **y-cut crystal**. The piezoelectric properties of a crystal depend upon its cut.
- ✦ **Frequency of Crystal.** Each crystal has a natural frequency like a pendulum.

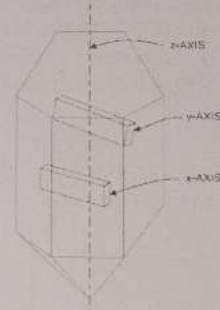

The natural frequency f of a crystal is given by: $f = \frac{K}{t}$ Where,

K = Constant that depends upon the cut & t = Thickness of the crystal.

- ✦ It is clear that frequency is inversely proportional to crystal thickness. The thinner the crystal, the greater is its natural frequency and vice-versa.
- ✦ However, extremely thin crystal may break because of vibrations. This puts a limit to the frequency obtainable. In practice, frequencies between 25 kHz to 5 MHz have been obtained with crystals.

❖ **WORKING OF QUARTZ CRYSTAL:-**

- ✦ In order to use crystal in an electronic circuit, it is placed between two metal plates. The arrangement then forms a capacitor with crystal as the dielectric as shown in Fig.
- ✦ If an a.c. voltage is applied across the plates, the crystal will start vibrating at the frequency of applied voltage. However, if the frequency of the applied voltage is made equal to the natural frequency of the crystal, resonance takes place and crystal vibrations reach a maximum value.
- ✦ This natural frequency is almost constant. Effects of temperature change can be eliminated by mounting the crystal in a temperature-controlled oven as in radio and television transmitters.

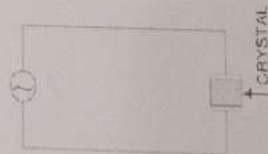

...P N GOUDA... (Alb) THE BEST ... (3) ... (3) ... (Alb) THE BEST ... P N GOUDA ...

CHAPTER - 7

[FIELD EFFECT TRANSISTOR (FET)]

❖ **INTRODUCTION: -**

- In the previous chapters, we have discussed the circuit applications of an ordinary transistor. In this type of transistor, both holes and electrons play part in the conduction process. For this reason, it is sometimes called a **Bipolar Transistor**.
- The ordinary or bipolar transistor has two principal disadvantages. **First**, it has low input impedance because of forward biased emitter junction. **Secondly**, it has considerable noise level.
- Although low input impedance problem may be improved by careful design and use of more than one transistor, yet it is difficult to achieve input impedance more than a few mega ohms.
- The field effect transistor (FET) has, by virtue of its construction and biasing, large input impedance which may be more than 100 mega ohms.
- The FET is generally much less noisy than the ordinary or bipolar transistor. The rapidly expanding FET market has led many semiconductor marketing managers to believe that this device will soon become the most important electronic device, primarily because of its integrated-circuit applications.

❖ **CLASSIFICATION OF FIELD EFFECT TRANSISTORS: -**

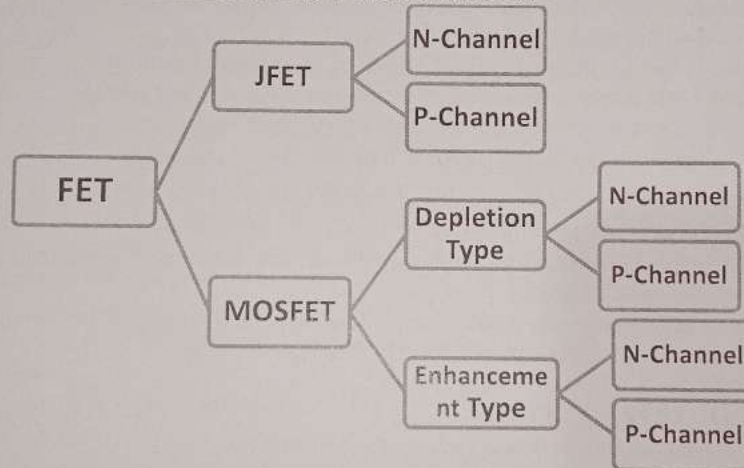

❖ Other types of C-MOS also There Such as: -CMOS, VMOS, LDMOS etc.

❖ **DIFFERENTIATION BETWEEN BJT & FET :-**

FET	BJT
✗ It means Field Effect Transistor	✗ Means Bipolar Junction Transistor
✗ Its three terminals are Source, Gate & Drain	✗ Its terminals are Emitter, Base & Collector .
✗ It is Unipolar devices i.e. Current in the device is carried either by electrons or holes.	✗ It is Bipolar devices i.e. Current in the device is carried by both electrons and holes.
✗ It is Voltage controlled device . i.e. Voltage at the gate or drain terminal controls the amount of current flowing through the devices.	✗ It is Current controlled device . i.e. Base Current controls the amount of collector current flowing through the devices.
✗ It has very High Input Resistance and Low Output Resistance.	✗ It has very Low Input Resistance and High Output Resistance.
✗ Low noisy operation	✗ High noisy operation
✗ It is Longer Life & High Efficiency.	✗ It is Shorter Life & Low Efficiency.
✗ It is much simpler to fabricate as IC and occupies less space on IC.	✗ It is comparatively difficult to fabricate as IC and occupies more space on IC than FET.
✗ It has Small gain bandwidth product.	✗ It has Large gain bandwidth product.
✗ It has higher switching speed.	✗ It has higher ^{lower} switching speed.

❖ **JUNCTION FIELD EFFECT TRANSISTOR (JFET) :-**

- A junction field effect transistor is a three terminal semiconductor device in which current conduction is by one type of carrier i.e., electrons or holes.
- In a JFET, the current conduction is either by electrons or holes and is controlled by means of an electric field between the gate electrode and the conducting channel of the device.
- The JFET has high input impedance and low noise level.

❖ **CONSTRUCTIONAL DETAILS.**

- A JFET consists of a p-type or n-type silicon bar containing two pn junctions at the sides as shown in Fig.
- The bar forms the conducting channel for the charge carriers. If the bar is of n-type, it is called n-channel JFET as shown in Fig (i) and if the bar is of p-type, it is called a p-channel JFET as shown in Fig (ii).
- The two pn junctions forming diodes are connected internally & a common terminal called **gate** is taken out.
- Other terminals are **source** and **drain** taken out from the bar as shown. Thus a JFET has essentially three terminals viz., Gate (G), Source (S) & Drain (D).

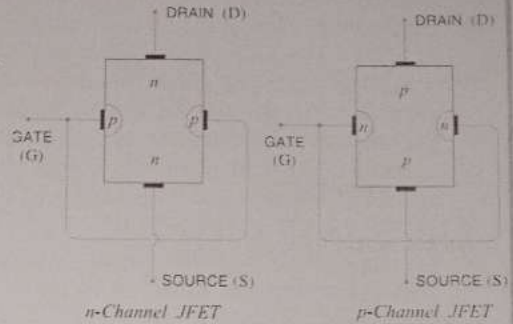

❖ **JFET POLARITIES: -**

- Fig (i) shows n-channel JFET polarities whereas Fig (ii) shows the p-channel JFET polarities.
- Note that in each case, voltage between gate and source is such that the gate is reverse biased.
- This is the normal way of JFET connection.
- The drain & source terminals are interchangeable i.e., either end can be used as source and the other end as drain.
- The following points may be noted:
 - ♣ The input circuit (i.e. gate to source) of a JFET is reverse biased. This means that the device has high input impedance.
 - ♣ The drain is so biased w.r.t. source that drain current I_D flows from the source to drain.
 - ♣ In all JFETs, source current I_S is equal to the drain current i.e. $I_S = I_D$.

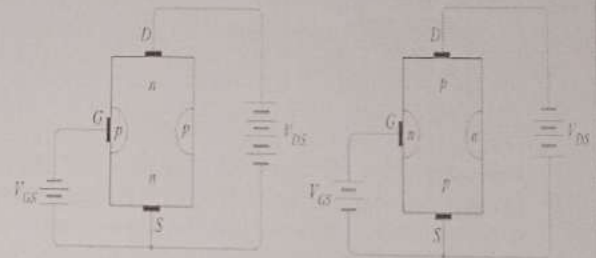

❖ **WORKING PRINCIPLE OF JFET:-**

➤ **Principle: -** Fig. shows the circuit of n-channel JFET with normal polarities. Note that the gate is reverse biased.

- The two pn junctions at the sides form two depletion layers. The current conduction by charge carriers (i.e. free electrons in this case) is through the channel between the two depletion layers and out of the drain.
- The width and hence resistance of this channel can be controlled by changing the input voltage V_{GS} .
- The greater the reverse voltage V_{GS} , the wider will be the depletion layers and narrower will be the conducting channel. The narrower channel means greater resistance and hence source to drain current decreases. Reverse will happen should V_{GS} decrease.
- Thus JFET operates on the principle that width and hence resistance of the conducting channel can be varied by changing the reverse voltage V_{GS} .
- In other words, the magnitude of drain current (I_D) can be changed by altering V_{GS} .
- **Working: -** The working of JFET is as under :
 - (i) When voltage V_{DS} is applied between drain & source terminals and voltage on the gate is zero [See the above Fig (i)], the two pn junctions at the sides of the bar establish depletion layers.
 - The electrons will flow from source to drain through a channel between the depletion layers.

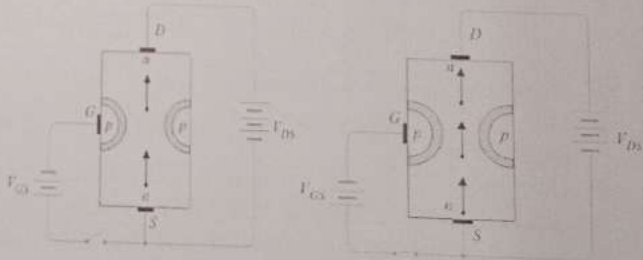

- The size of these layers determines width of the channel & hence current conduction through the bar.
- (ii) When a reverse voltage V_{GS} is applied between the gate and source [See Fig (ii)], the width of the depletion layers is increased.
- This reduces the width of conducting channel, thereby increasing the resistance of n-type bar. Consequently, the current from source to drain is decreased.
- On the other hand, if the reverse voltage on the gate is decreased, the width of the depletion layers also decreases. This increases the width of the conducting channel and hence source to drain current.
- It is clear from the above discussion that current from source to drain can be controlled by the application of potential (i.e. electric field) on the gate.
- For this reason, the device is called field effect transistor. It may be noted that a p-channel JFET operates in the same manner as an n-channel JFET except that channel current carriers will be the holes instead of electrons and the polarities of V_{GS} and V_{DS} are reversed.

❖ **JFET AS AN AMPLIFIER :-**

- Fig shows JFET amplifier circuit. The weak signal is applied between gate and source and amplified output is obtained in the drain-source circuit. For the proper operation of JFET, the gate must be negative w.r.t. source i.e., input circuit should always be reverse biased.
- This is achieved either by inserting a battery V_{GG} in the gate circuit or by a circuit known as biasing circuit.
- In the present case, we are providing biasing by the battery V_{GG} . A small change in the reverse bias on the gate produces a large change in drain current.
- This fact makes JFET capable of raising the strength of a weak signal. During the positive half of signal, the reverse bias on the gate decreases. This increases the channel width and hence the drain current.
- During the negative half-cycle of the signal, the reverse voltage on the gate increases. Consequently, the drain current decreases.
- The result is that a small change in voltage at the gate produces a large change in drain current.
- These large variations in drain current produce large output across the load R_L . In this way, JFET acts as an amplifier

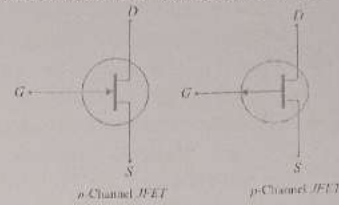

[Schematic Symbol of JFET]

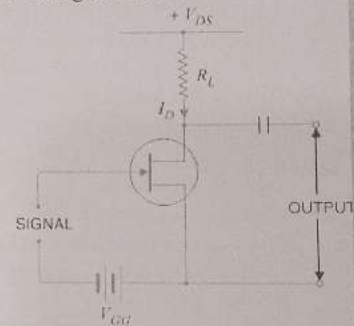

❖ **OUTPUT CHARACTERISTICS OF JFET**

- The curve between drain current (I_D) and drain-source voltage (V_{DS}) of a JFET at constant gate source voltage (V_{GS}) is known as output characteristics of JFET.
- Fig shows circuit for determining output characteristics of JFET.
- Keeping V_{GS} fixed at some value, say 1V, the drain source voltage is changed in steps.
- Corresponding to each value of V_{DS} , the drain current I_D is noted.
- A plot of these values gives output characteristic of JFET at $V_{GS} = 1V$.
- Repeating similar procedure, output characteristics at other gate-source voltages can be drawn. Fig. shows a family of output characteristics.

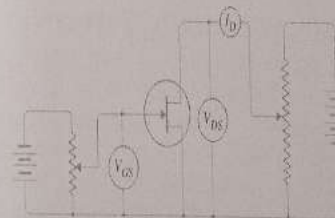

✦ **The following points may be noted from the characteristics:**

- (i) At first, the drain current I_D rises rapidly with drain-source voltage V_{DS} but then becomes constant.
- The drain-source voltage above which drain current becomes constant is known as pinch off voltage. Thus in Fig. OA is the pinch off voltage V_P .
- (ii) After pinch off voltage, the channel width becomes so narrow that depletion layers almost touch each other.
- The drain current passes through the small passage between these layers.
- Thus increase in drain current is very small with V_{DS} above pinch off voltage.
- Consequently, drain current remains constant. The characteristics resemble that of a pentode valve.

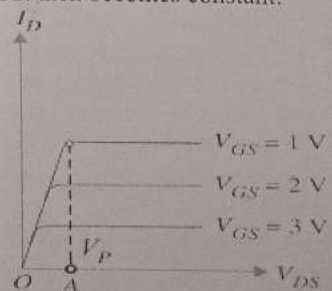

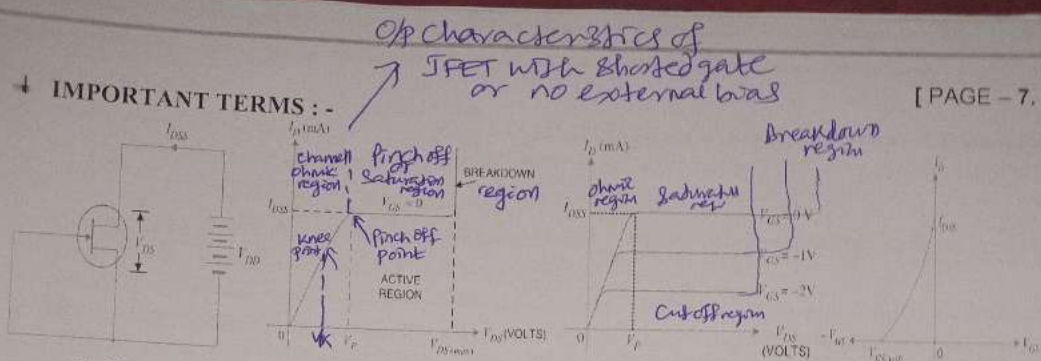

- 1. Shorted-Gate Drain Current (I_{DSS}):** - It is the drain current with source short-circuited to gate (i.e. $V_{GS} = 0$) and drain voltage (V_{DS}) equal to pinch off voltage. It is sometimes called zero-bias current.
- 2. Pinch Off Voltage (V_P):** - It is the minimum drain-source voltage at which the drain current essentially becomes constant.
- 3. Gate-Source Cut Off Voltage $V_{GS}(\text{off})$:** - It is the gate-source voltage where the channel is completely cut off & the drain current becomes zero.

PARAMETERS OF JFET: - Like vacuum tubes, a JFET has certain parameters which determine its performance in a circuit. The main parameters of JFET are: - (i) A.C. drain resistance (ii) Transconductance (iii) Amplification factor.

(i) A.C. Drain Resistance (r_d). Corresponding to the a.c. plate resistance, we have a.c. drain resistance in a JFET. It may be defined as follows: - It is the ratio of change in drain-source voltage (ΔV_{DS}) to the change in drain current (ΔI_D) at constant gate-source voltage i.e.

$$\text{A.C. Drain Resistance, } r_d = \frac{\Delta V_{DS}}{\Delta I_D} \text{ at constant } V_{GS}$$

- For instance, if a change in drain voltage of 2 V produces a change in drain current of 0.02 mA, then, a.c. drain resistance, $r_d = \frac{2V}{0.02 \text{ mA}} = 100 \text{ k}\Omega$
- Referring to the output characteristics of a JFET in Fig., it is clear that above the pinch off voltage, the change in I_D is small for a change in V_{DS} because the curve is almost flat.
- Therefore, drain resistance of a JFET has a large value, ranging from 10 k Ω to 1 M Ω .
- (ii) Transconductance (g_{fs}):** - The control that the gate voltage has over the drain current is measured by transconductance g_{fs} & is similar to transconductance (g_m) of the tube. It may be defined as follows: - It is the ratio of change in drain current (ΔI_D) to the change in gate-source voltage (ΔV_{GS}) at constant drain-source voltage i.e.

$$\text{Transconductance, } g_{fs} = \frac{\Delta I_D}{\Delta V_{GS}} \text{ at constant } V_{DS}$$

- The transconductance of a JFET is usually expressed either in mA/volt or micro mho. As an example, if a change in gate voltage of 0.1 V causes a change in drain current of 0.3 mA, then, Transconductance, $g_{fs} = \frac{0.3 \text{ mA}}{0.1 \text{ V}} = 3 \text{ mA/V} = 3 \times 10^{-3} \text{ A/V}$ or mho or S (Siemens) $= 3 \times 10^{-3} \times 10^6 \mu \text{ mho} = 3000 \mu \text{ mho}$ (or μS)
- (iii) Amplification Factor (μ).** It is the ratio of change in drain-source voltage (ΔV_{DS}) to the change in gate-source voltage (ΔV_{GS}) at constant drain current i.e.

$$\text{Amplification Factor, } \mu = \frac{\Delta V_{DS}}{\Delta V_{GS}} \text{ at constant } I_D$$

- Amplification factor of a JFET indicates how much more control the gate voltage has over drain current than has the drain voltage.
- For instance, if the amplification factor of a JFET is 50, it means that gate voltage is 50 times as effective as the drain voltage in controlling the drain current.

❖ **RELATION AMONG JFET PARAMETERS: -**

➤ The relationship among JFET parameters can be established as under :

We know $\mu = \frac{\Delta V_{DS}}{\Delta V_{GS}}$

➤ Multiplying the numerator and denominator on R.H.S. by ΔI_D , we get,

$$\mu = \frac{\Delta V_{DS}}{\Delta V_{GS}} \times \frac{\Delta I_D}{\Delta I_D} = \frac{\Delta V_{DS}}{\Delta I_D} \times \frac{\Delta I_D}{\Delta V_{GS}} \rightarrow$$

$$\mu = r_d \times g_{fs}$$

➔ Amplification Factor = A.C. Drain Resistance × Transconductance

❖ **JFET BIASING: -**

➤ For the proper operation of n-channel JFET, gate must be negative w.r.t. source. This can be achieved either by inserting a battery in the gate circuit or by a circuit known as biasing circuit.

➤ The latter method is preferred because batteries are costly and require frequent replacement.

1. **Bias Battery:** - In this method, JFET is biased by a bias battery V_{GG} . This battery ensures that gate is always negative w.r.t. source during all parts of the signal.

2. **Biasing circuit:** - The biasing circuit uses supply voltage V_{DD} to provide the necessary bias. Two most commonly used methods are (i) Self-Bias (ii) Potential Divider Method.

❖ **SELF-BIAS FOR JFET :-**

➤ Fig shows the self-bias method for n-channel JFET. The resistor R_S is the bias resistor.

➤ The d.c. component of drain current flowing through R_S produces the desired bias voltage.

Voltage across R_S , $V_S = I_D R_S$

➤ Since gate current is negligibly small, the gate terminal is at d.c. ground i.e., $V_G = 0$.

$\therefore V_{GS} = V_G - V_S = 0 - I_D R_S$ or $V_{GS} = -I_D R_S$

➤ Thus bias voltage V_{GS} keeps gate negative w.r.t. source.

➤ **Operating point: -**

➤ The operating point (i.e., zero signals I_D & V_{DS}) can be easily determined. Since the parameters of the JFET are usually known, zero signal I_D can be calculated from the following relation :

$$I_D = I_{DSS} \left(1 - \frac{\Delta V_{GS}}{\Delta V_{GS(off)}}\right)^2$$

Also $V_{DS} = V_{DD} - I_D (R_D + R_S)$

➤ Thus d.c. conditions of JFET amplifier are fully specified i.e. operating point for the circuit is (V_{DS}, I_D) .

Also, $R_S = \frac{|V_{GS}|}{|I_D|}$

➤ Note that gate resistor R_G does not affect bias because voltage across it is zero.

➤ **Midpoint Bias: -** It is often desirable to bias a JFET near the midpoint of its transfer characteristic curve where $I_D = I_{DSS}/2$. When signal is applied, the midpoint bias allows a maximum amount of drain current swing between I_{DSS} and 0.

➤ It can be proved that when $V_{GS} = V_{GS(off)}/3.4$, midpoint bias conditions are obtained for I_D .

$$I_D = I_{DSS} \left(1 - \frac{\Delta V_{GS}}{\Delta V_{GS(off)}}\right)^2 = I_{DSS} \left(1 - \frac{\Delta V_{GS(off)/3.4}}{\Delta V_{GS(off)}}\right)^2 = 0.5 I_{DSS}$$

➤ To set drain voltage at midpoint ($V_D = V_{DD}/2$), select a value of R_D to produce the desired voltage drop.

❖ **JFET with Voltage-Divider Bias :-**

➤ Fig shows potential divider method of biasing a JFET. This circuit is identical to that used for a transistor.

➤ The resistors R_1 and R_2 form a voltage divider across drain supply V_{DD} . The voltage $V_2 (= V_G)$ across R_2 provides the necessary bias.

$$V_2 = V_G = \frac{V_{DD}}{R_1 + R_2} \times R_2$$

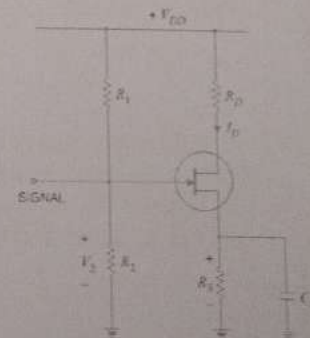
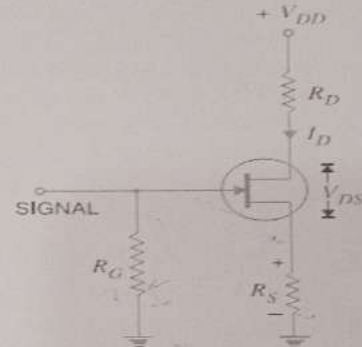

Now $V_2 = V_{GS} + I_D R_S$ Or $V_{GS} = V_2 - I_D R_S$

- The circuit is so designed that $I_D R_S$ is larger than V_2 so that V_{GS} is negative. This provides correct bias voltage. We can find the operating point as under:

$$I_D = \frac{V_2 - V_{GS}}{R_S} \text{ and } V_{DS} = V_{DD} - I_D (R_D + R_S)$$

- Although the circuit of voltage-divider bias is a bit complex, yet the advantage of this method of biasing is that it provides good stability of the operating point.
- The input impedance Z_i of this circuit is given by : $Z_i = R_1 \parallel R_2$

❖ **JFET Connections: -**

- There are three leads in a JFET viz., source, gate and drain terminals. However, when JFET is to be connected in a circuit, we require four terminals; two for the input and two for the output.
- This difficulty is overcome by making one terminal of the JFET common to both input and output terminals. Accordingly, a JFET can be connected in a circuit in the following three ways:

- ✦ Common Source connection
- ✦ Common Gate connection
- ✦ Common Drain connection

- The common source connection is the most widely used arrangement. It is because this connection provides high input impedance, good voltage gain and moderate output impedance.

- However, the circuit produces a phase reversal i.e., output signal is 180° out of phase with the input signal. Fig. shows a common source n-channel JFET amplifier.
- Note that source terminal is common to both input and output.

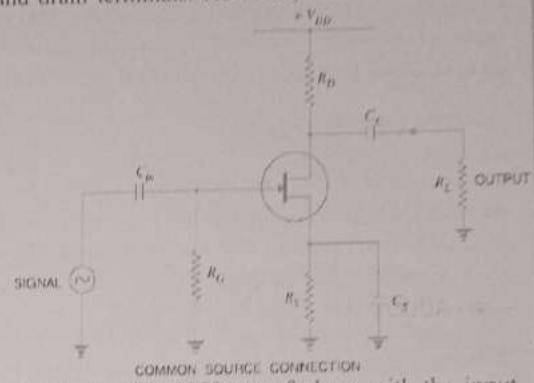

✦ **JFET Applications: -**

- The high input impedance and low output impedance and low noise level make JFET far superior to the bipolar transistor. Some of the circuit applications of JFET are :
 - ✦ As a Buffer amplifier
 - ✦ As Phase-shift oscillators
 - ✦ As RF amplifier

---P N GOUDA---Alb THE BEST---P N GOUDA---

Transfer characteristics

It is drawn between gate voltage & drain current by keeping drain to source voltage constant at pinch off voltage. When the gate is in zero potential the max^m drain current flowing through the transistor is shorted gate drain current (I_{DSS}). When the gate source voltage (V_{GS}) is increased in the negative region, the drain current I_D decreases.

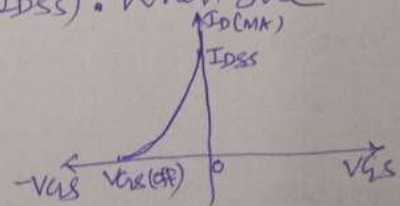

CHAPTER - 8

OPERATIONAL AMPLIFIERS

❖ INTRODUCTION

The operational amplifier is an extremely efficient and versatile device. Its applications span the broad electronic industry filling requirements for signal conditioning, special transfer functions, analog instrumentation, analog computation, and special systems design. The analog assets of simplicity and precision characterize circuits utilizing operational amplifiers.

❖ OP-AMP BASICS

Operational amplifiers are convenient building blocks that can be used to build amplifiers, filters, and even an analog computer. Op-amps are integrated circuits composed of many transistors & resistors such that the resulting circuit follows a certain set of rules. The most common type of op-amp is the voltage feedback type and that's what we'll use.

The schematic representation of an op-amp is shown to the left. There are two input pins (non-inverting and inverting), an output pin, and two power pins. The ideal op-amp has infinite gain. It amplifies the voltage difference between the two inputs and that voltage appears at the output. Without feedback this op-amp would act like a comparator (i.e. when the non-inverting input is at a higher voltage than the inverting input the output will be high, when the inputs are reversed the output will be low).

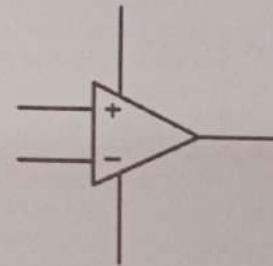

❖ NON-INVERTING AMPLIFIER:

No current flows into the input, $R_{in} = \infty$ The output adjusts to bring V_{in-} to the same voltage as V_{in+} . Therefore $V_{in-} = V_{in}$ and since no current flows into V_{in-} the same current must flow through R_1 & R_2 . V_{out} is therefore $V_{R1} + V_{R2} = V_{in-} + IR_2 = V_{in-} + (V_{in}/R_1)R_2$.

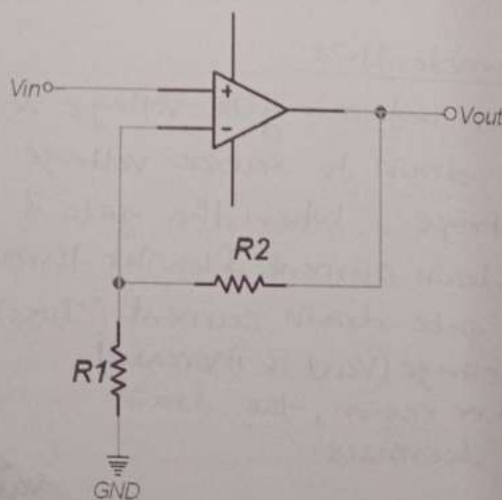

❖ INVERTING AMPLIFIER

Because no current flows into the input pins there can't be any voltage drop across the $R1 \parallel R2$. V_{in+} is therefore at 0V (this is called a virtual ground). The output will adjust such that V_{in-} is at zero volts. This makes $R_{in} = R1$ (not ∞). The current through $R1$ & $R2$ have to be the same since no current goes into the input pins.

Therefore $I = V_{in}/R1$. $V_{out} = V_{in+} - IR2 = 0 - (V_{in}/R1)R2$. Therefore $V_{out} = -V_{in}(R2/R1)$

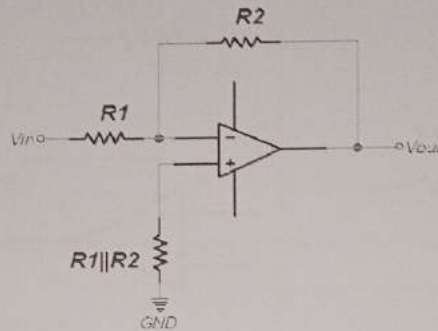

❖ SUMMING AMPLIFIER:

Since V_{in-} is a virtual ground adding $V2$ and $R2$ (and $V3$ & $R3$) doesn't change the current flowing through $R1$ from $V1$. Each input contributes to the output using the following equation:

$$V_{out} = -V1(R4/R1) - V2(R4/R2) - V3(R4/R3).$$

The input impedance for the $V1$ input is still $R1$, similarly $V2$'s input impedance is $R2$ and $V3$'s is $R3$. Most of the time the parallel combination of $R1$ - $R4$ isn't used and V_{in+} is grounded.

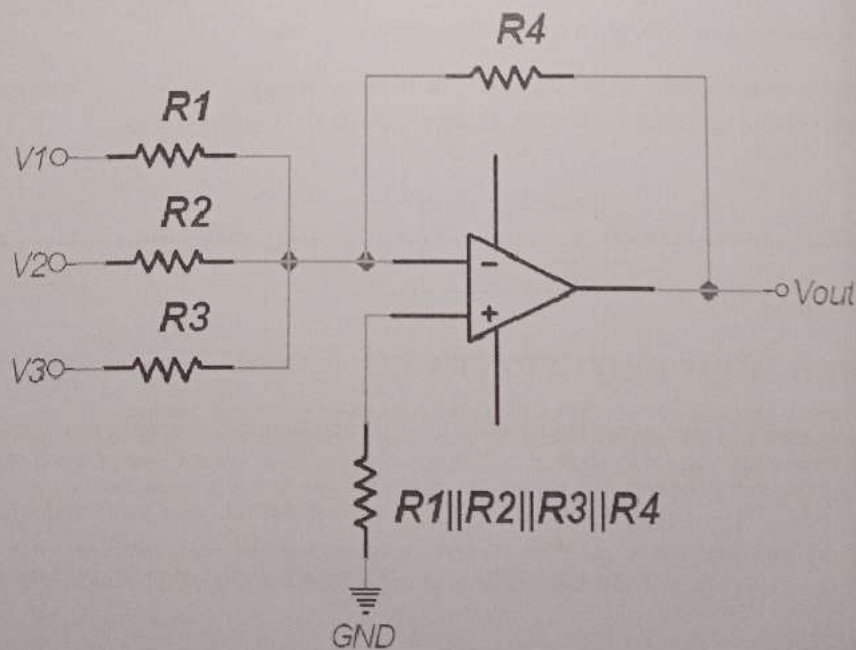

❖ DIFFERENCE AMPLIFIER:

You can work out the gain as before using the two rules (no current flows into the inputs, and the output will adjust to bring V_{in-} to V_{in+}). The result is $V_{out} = 2(V_2 - V_1) * (R_2/R_1)$. Also, $R_{in(-)} = R_1$, $R_{in(+)} = R_1 + R_2$.

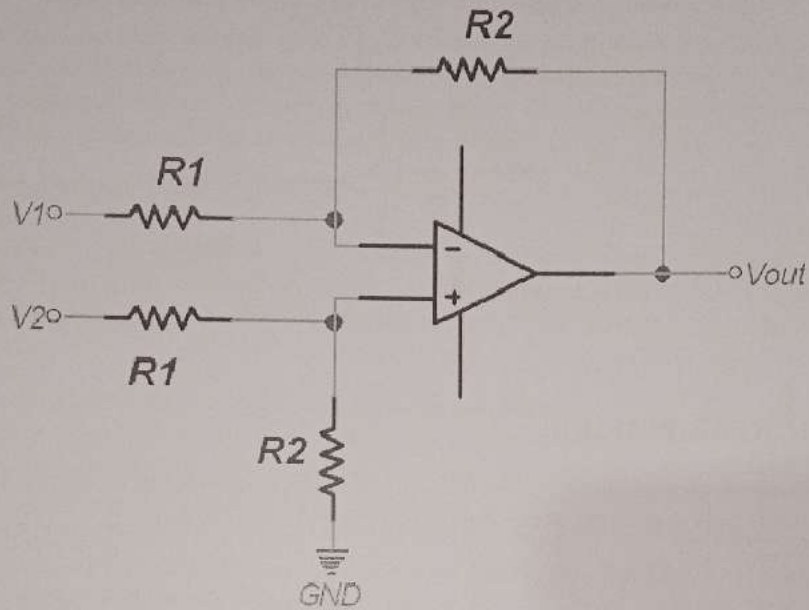

❖ COMMON-MODE OP- AMP

These type of op-amp have common mode voltage to both terminals.

It means without connecting the same voltage at both the terminal we may connect one voltage or either inverting or non-inverting terminal and other is connected with short to that voltage.

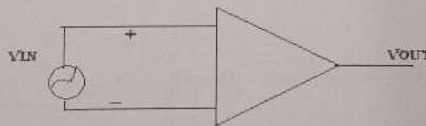

❖ COMMON MODE REJECTION RATIO

Common mode rejection ratio which is defined as the ratio of differential gain to common mode

$$CMRR = A_d / A_{cm}$$

$$A_d = V_o / V_d \quad , \quad A_{cm} = V_o / V_{cm}$$

As the gain is generally high so CMRR is used to express as a logarithmic gain function

$$CMRRR = 20 \log A_d / A_{cm}$$

❖ OPERATIONAL - AMPLIFIER WITH FEEDBACK

Non-Inverting Amplifier

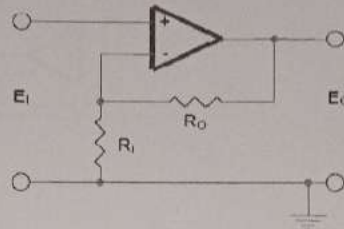

$$E_o = \left(1 + \frac{R_o}{R_i} \right) \cdot E_i$$

The same voltage must appear at the inverting and non-inverting inputs, so that:
 $(E-) = (E+) = E_i$

From the voltage division formula:

$$E_i = \frac{R_i}{R_i + R_o} E_o$$

$$\frac{E_o}{E_i} = \frac{R_i + R_o}{R_i} = 1 + \frac{R_o}{R_i}$$

The input impedance of the non-inverting amplifier circuit is infinite since no current flows into the inverting input. Output impedance is zero since output voltage is ideally independent of output current. Closed loop gain is $1 + \frac{R_o}{R_i}$ hence can be any desired value above unity.

Such circuits are widely used in control and instrumentation where non-inverting gain is required.

INVERTING AMPLIFIER

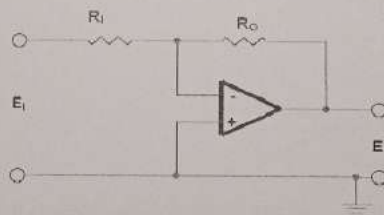

$$\frac{E_o}{E_i} = -\frac{R_o}{R_i}$$

Figure 17. Inverting Amplifier

The inverting amplifier appears in figure 17. This circuit and its many variations form the bulk of commonly used operational amplifier circuitry. Single ended input and output versions were first used, and they became the basis of analog computation. Today's modern differential input amplifier is used as an inverting amplifier by grounding the non-inverting input and applying the input signal to the inverting input terminal.

Since the amplifier draws no input current and the input voltage approaches zero when the feedback loop is closed (the two summing point restraints), we may write:

$$\frac{E_i}{R_i} = \frac{E_o}{R_o} = 0$$

Differentiator

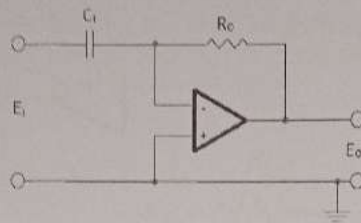

$$E_o = -R_o C_i \frac{dE_i}{dt}$$

Figure 22. Differentiator Circuit

Using a capacitor as the input element to the inverting amplifier, figure 22, yields a differentiator circuit. Consideration of the device in figure 23 will give a feeling for the differentiator circuit.

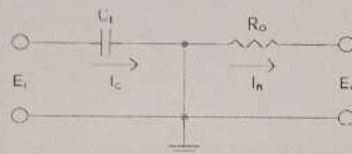

Figure 23. An Intuitive Picture of the Differentiator

Since the inverting input is at ground potential:

$$I_c = C_i \frac{dE_i}{dt}, \text{ and } I_c - I_R = 0$$

so that:

$$C_i \frac{dE_i}{dt} + \frac{E_o}{R_o} = 0$$

$$E_o = -R_o C_i \frac{dE_i}{dt}$$

It should be mentioned that of all the circuits presented in this section, the differentiator is the one that will operate least successfully with real components. The capacitive input makes it particularly susceptible to random noise and special techniques will be discussed later for remedying this effect.

Integrator

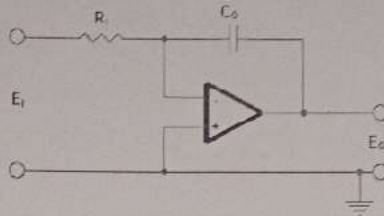

$$E_o = \frac{-1}{R_i C_o} \int E_i dt$$

Figure 21. Integrator Circuit

If a capacitor is used as the feedback element in the inverting amplifier, shown in figure 21, the result is an integrator. An intuitive grasp of the integrator action may be obtained from the statement under the section, "Current Output," that current through the feedback loop charges the capacitor and is stored there as a voltage from the output to ground. This is a voltage input current integrator.

Voltage Adder

In a great many practical applications the input to the inverting amplifier is more than one voltage. The simplest form of multiple inputs is shown in figure 24.

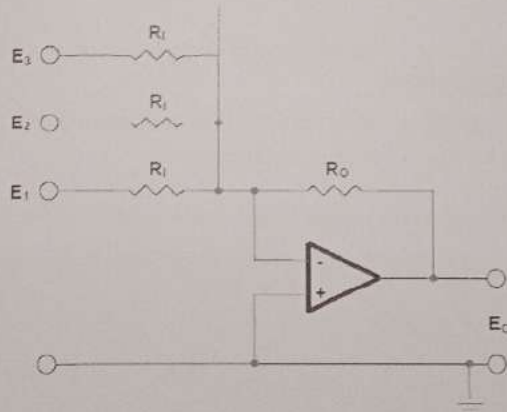

$$E_o = \frac{-R_o}{R_i} (E_1 + E_2 + E_3 + \dots)$$

Figure 24. Voltage Adding Circuit

Current in the feedback loop is the algebraic sum of the current due to each input. Each source, E_1 , E_2 , etc., contributes to the total current, and no interaction occurs between them. All inputs "see" R_i as the input impedance, while gain is $\frac{-R_o}{R_i}$. Direct voltage addition may be obtained with $R_o = R_i$.

THE VOLTAGE FOLLOWER

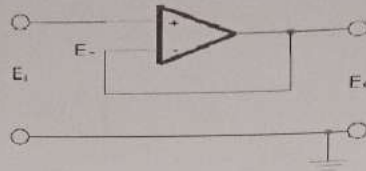

Let the voltage at the inverting input with respect to the non-inverting input be E_- .

By Kirchoff's voltage law:

$$(E_-) + E_i = E_o$$

But by definition:

$$E_o = -A(E_-)$$

where A is the gain of the operational amplifier

Then:

$$(E_-) = \frac{-E_o}{A}$$

And substituting:

$$E_i - \frac{E_o}{A} = E_o$$

Letting A go to infinity, $\frac{E_o}{A}$ approaches zero, and:

$$E_o = E_i$$

❖ VOLTAGE SUBTRACTOR

- Generally Subtraction of signals are being performed by subtracting one signal from another signal. These types of subtractor are always used in analog signals.

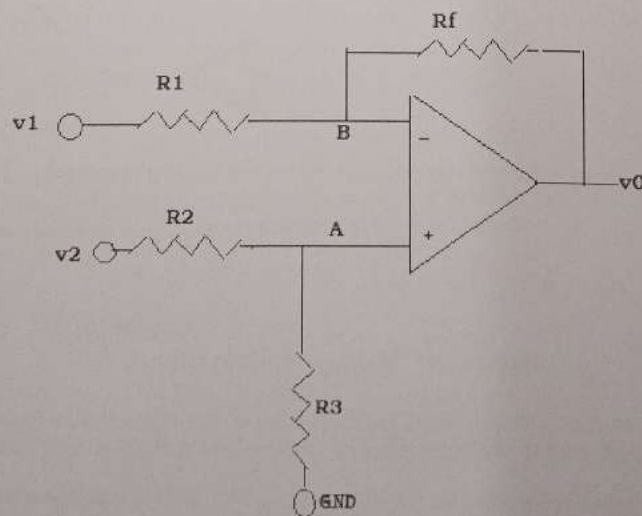

Voltage across terminal A can be found by using voltage division rule and we know that voltage across A is equals to the B so $V_A = V_B$

$$V_A = V_2 \cdot \frac{R_2}{R_2 + R_3} = V_B$$

Applying nodal analysis in terminal B the equation becomes

$$(V_B - V_1)/R_1 + (V_B - V_0)/R_F = 0$$

$$V_B/R_1 + (V_B/R_F - V_1/R_1) = V_0/R_F$$

$$V_B (1/R_1 + 1/R_F) - V_1/R_1 = V_0/R_F$$

But we know that $V_B = V_2 \cdot \frac{R_2}{R_2 + R_3}$

$$(V_2 \cdot \frac{R_2}{R_2 + R_3}) [(R_F + R_1)/R_1 \cdot R_F] - V_1/R_1 = V_0/R_F$$

$$(V_2 \cdot \frac{R_2}{R_2 + R_3}) [(R_F + R_1)/R_1] - V_1 \cdot \frac{R_F}{R_1} = V_0$$

$$V_0 = (V_2 \cdot \frac{R_2}{R_2 + R_3}) [1 + \frac{R_F}{R_1}] - (V_1 \cdot \frac{R_F}{R_1})$$

If we put $R_F = R_1 = R_2 = R_3 = 1 \text{ K}\Omega$

The output voltage V_0 becomes

$$V_0 = V_2 - V_1$$

SLEW RATE

It is the ratio of change in output voltage to change in time

$$S.R = \Delta V_0 / \Delta T \text{ (V}/\mu\text{s)}$$