

AUTOMOTIVE ENGINE

महेश्वरकाश्या मयार

Introduction: -

What is an Engine? or Definition of Engine

An Engine is a device which transforms one form of energy into the another form. However, while transforming energy from one form to another, the efficiency of conversion plays important role. Basically, most of the engines convert thermal energy into mechanical work and therefore they called "Heat Engine".

Heat Engine → Heat engine is a device which transforms the chemical energy of fuel into thermal energy and utilizes this thermal energy to perform useful work. Thus, thermal energy is converted into the mechanical energy in a heat engine.

Heat Engines are broadly classified into two categories

- (i) Internal combustion Engine (IC Engine)
- (ii) External combustion Engine (EC Engine)

Internal combustion Engine :- Internal combustion engines are those engines which are combustion takes place outside the engine.

External combustion Engine :- External combustion engines are those in which combustion takes place outside of the engine

Examples

IC → gasoline or diesel engines

EC → Steam Engine or steam turbine.

Classification and some basic details of Heat Engines
 Engines whether internal combustion or external combustion
 are of two types i.e

- (i) Rotary engines (ii) Reciprocating engines

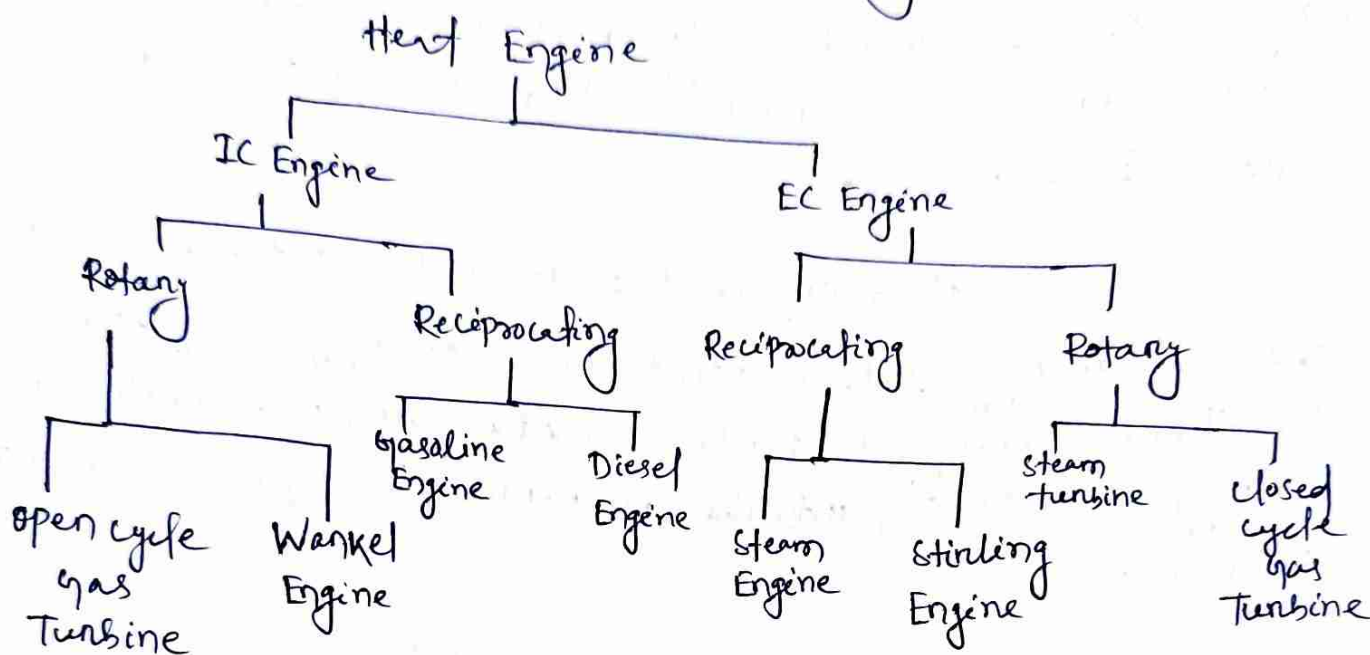

Classification of IC Engines

IC Engines can be classified on the following basis.

(a) Thermodynamic cycle

- (i) Otto or constant volume cycle
- (ii) Diesel or constant pressure cycle
- (iii) Dual or limited pressure cycle

(b) Number of strokes per cycle:-

- (i) 4-stroke Engine → The engine cycle is completed in four strokes of piston.
- (ii) 2-stroke Engine → The engine cycle is completed in two strokes of the piston.

The distance travelled by the piston inside the cylinder from one extreme end to other extreme end, i.e top dead centre to bottom dead centre is called stroke.

(c) Ignition system

- (i) Spark Ignition (S.I) Engine
- (ii) Compression Ignition (C.I) Engine

(d) fuel is used

- (i) Petrol Engine
- (ii) oil or Diesel Engine
- (iii) Gas Engines
- (iv) Multifuel Engines

(e) Cooling system

- (i) Water Cooled
- (ii) Air cooled

(f) Numbers of cylinder

- (i) single cylinder engine
- (ii) Multicylinder engine.

① Petrol Engine and its constructional details

1.1 working principle of two stroke and four stroke petrol engine

working principle of 4-stroke petrol engine.

4-stroke: - The Engine cycle is completed in four strokes of the piston or power is developed for every two revolutions of the crankshaft.

In a four stroke engine the cycle operation is completed in four strokes of the piston or two revolution of the crankshaft. During the four strokes there are five events are to be completed i.e - suction, compression, combustion, expansion & Exhaust. And each and every strokes consists of 180° of crankshaft rotation and hence a four stroke cycle is completed through 720° .

4-stroke S.I engine consists of following four stroke.

- (i) suction stroke or intake stroke
- (ii) compression stroke
- (iii) Expansion or Power stroke
- (iv) Exhaust stroke.

SUCTION STROKE :-

During the suction stroke, the inlet valve is opened and the exhaust valve is closed. When the piston moves down from the TDC to BDC, a partial vacuum is developed inside the engine cylinder. As a result, the mixture of air and petrol is sucked into the cylinder. When the piston reaches the BDC, the inlet valve is closed. The flywheel makes a half revolution.

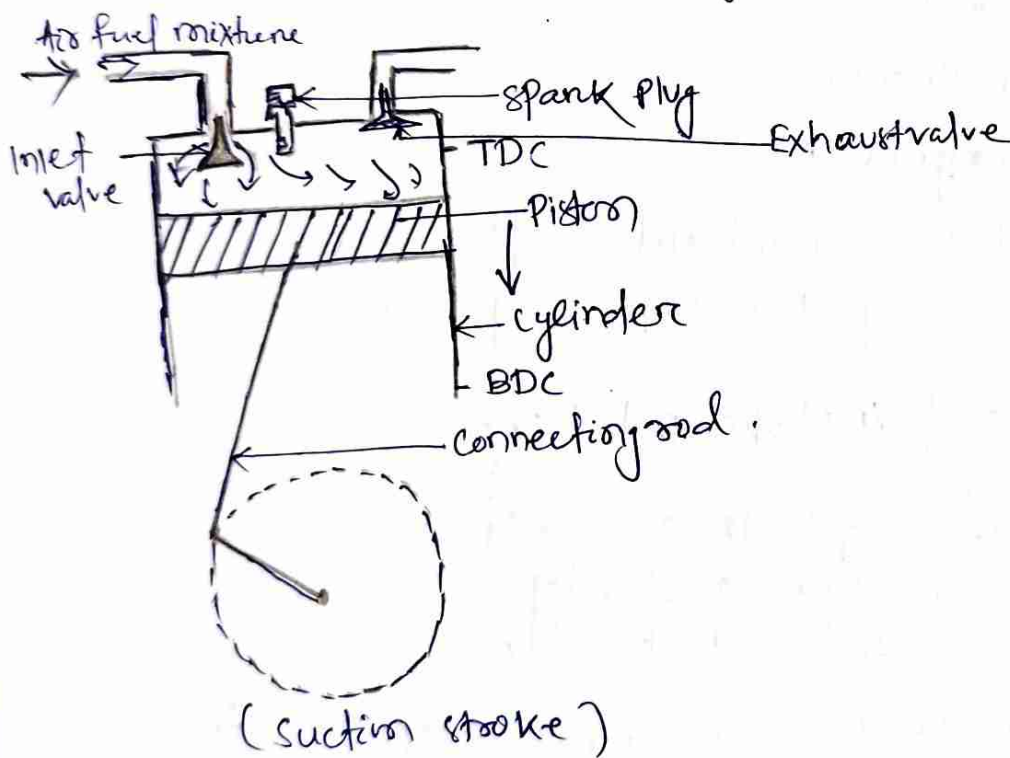

COMPRESSION STROKE

During the compression stroke both the inlet and the exhaust valves are closed. The piston moves from BDC to TDC and flywheel makes another revolution. The mixture which is sucked into the cylinder during the suction stroke, is now compressed in the combustion chamber and developed high pressure.

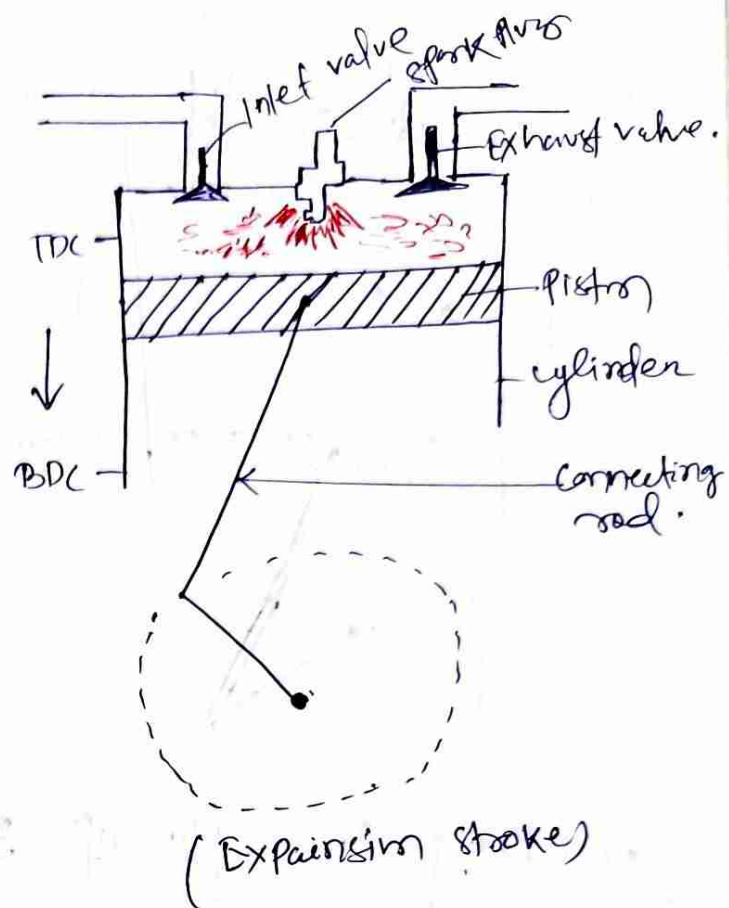
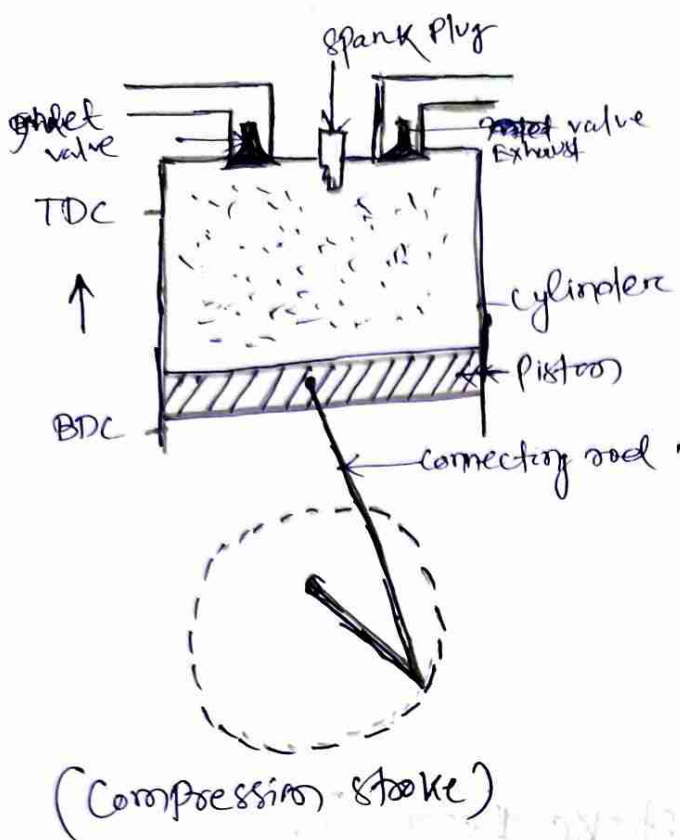

EXPANSION

EXPANSION OR POWER STROKE

Near the end of the compression stroke, there is an electric discharge across the spark plug and that initiates the combustion process. The fuel burns and the combustion process is completed within a few milliseconds. It is assumed that the combustion process takes place at constant volume. The burning gases expand and push the piston down to the BDC from TDC. When it reaches near the BDC, the exhaust valve opens. The flywheel turns by another half revolution. Both inlet and exhaust valves remain close during this power stroke.

EXHAUST STROKE

During the exhaust stroke, the inlet valve is closed and the exhaust valve is opened. The piston rises up from the BDC to TDC. When the burnt gases are pushed out of the cylinder, the pressure inside the engine cylinder is a little more than the atmospheric pressure.

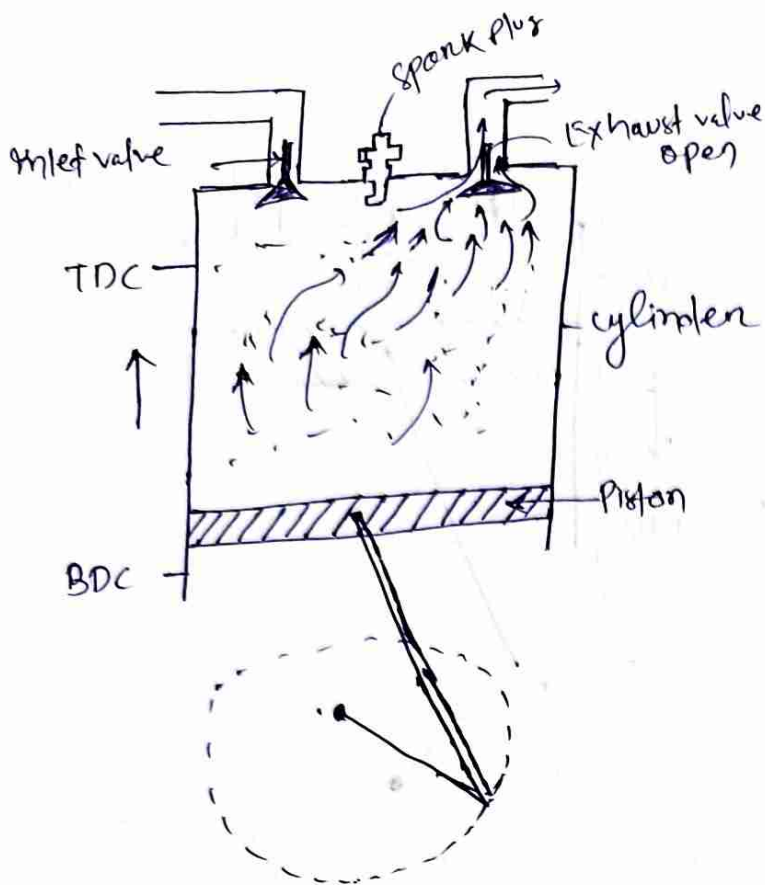

(These are the movement of piston) upward & downward motion.

Working Principle of 2-Stroke Petrol Engine.

2-Stroke :- The engine cycle is completed in two strokes of the piston as power is developed for every revolution of the crank shaft.

2-Stroke engine developed by Dugly Clerk in 1878

First stroke (suction stroke and compression stroke)

During the first stroke, as the piston moves up from the BDC, it closes all three ports, namely the inlet, transfer and exhaust ports. The piston compresses the air fuel mixture at inside the cylinder, when the piston is near the TDC, the petrol mixture is fully compressed. The spark plug then ignites the mixture. Power is produced with the burning of mixture. This power is transmitted to the crank shaft through the connecting rod. During this stroke, partial vacuum is produced inside the crank case.

The inlet port is opened and the petrol mixture enters through into the crank case.

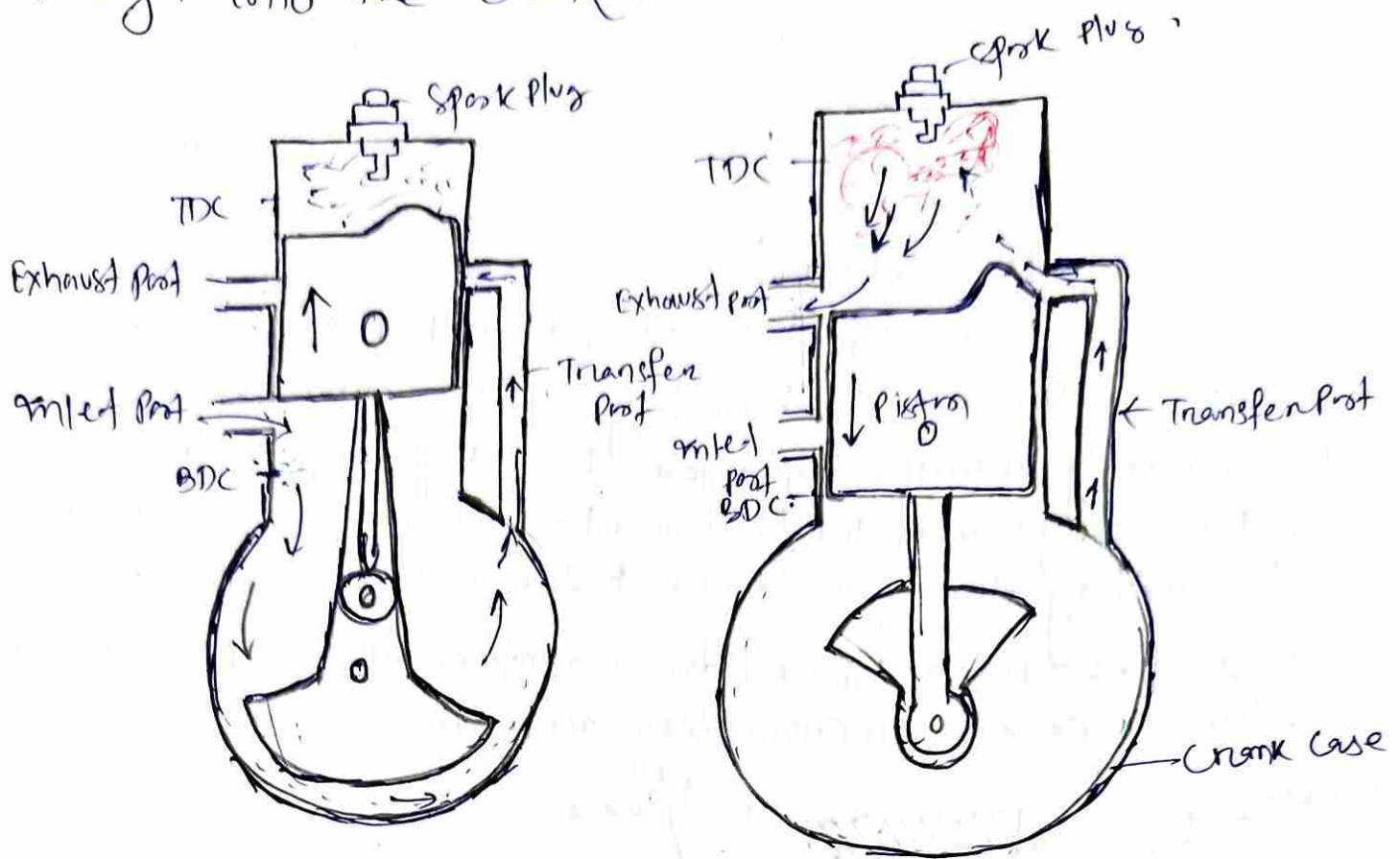

Second stroke (Power & Exhaust stroke)

During the second stroke, the piston moves down from the TDC and the inlet port is closed. The fuel mixture is compressed by the bottom of the piston and the crank. It then gets pushed into the cylinder through the transfer port.

Since the exhaust port is open, the exhaust gas leaves the cylinder through it. Some exhaust gases maybe, however remain inside the cylinder. The special shape of the piston head deflects the fresh charge of the air fuel mixture up into the cylinder. The mixture flows down and pushes the exhaust gas through the exhaust port. This process is called scavenging. Once the fly wheel has completed one revolution, the cycle of the operation is repeated.

1.2 Constructional details of Petrol Engine with materials
Engine components like Piston, Cylinder block, valve, connecting rod, crank shaft, crank pin.

Piston :- function of the piston :-

It is a cylindrical component fitted into the cylinder forming the moving boundary of the combustion system. It fits perfectly into the cylinder providing a gas-tight space with piston rings and the lubricant. It forms the 1st link in transmitting the gas forces to the output shaft. The movement of the piston up and down motion of the piston in the cylinder is called reciprocating motion.

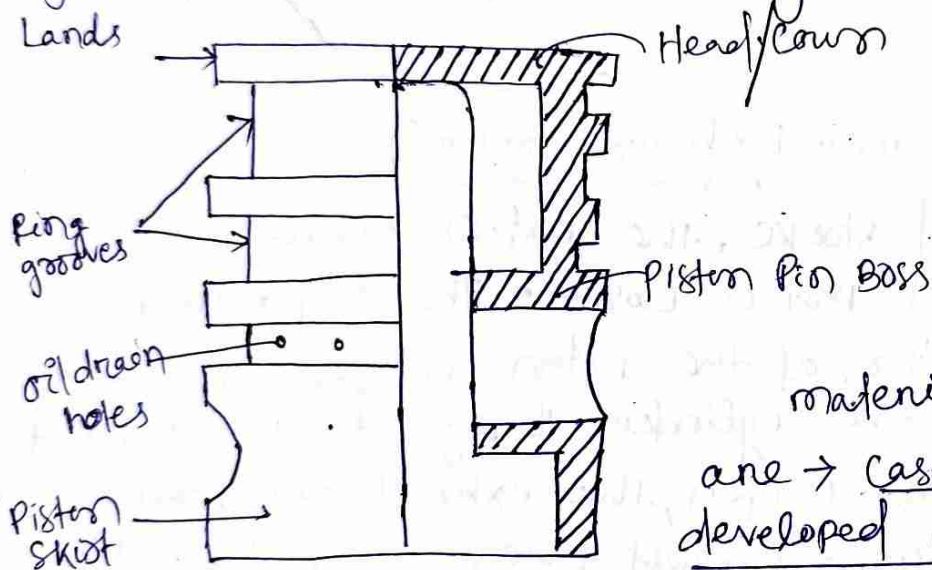

material used for the piston
are → cast iron, as the technology
developed aluminium alloy.

Cylinder Block :- cylinder block is the main supporting structure for the various components. The cylinder block is usually in one piece as it is cast in single block. The cylinder head is mounted on the cylinder block. It has cylinders for the piston, ports for the valves & passages for the cooling water to flow. oil passages are provided for lubrication. These are tunnels in the cylinder block for push rods. These tunnels carry the crank shaft which contains cam shaft.

→ Cylinder head gasket is incorporated betⁿ the cylinder block and the cylinder head. The cylinder head is held tight to the cylinder block by number of bolts or studs.

→ The bottom portion of the cylinder block is called crank case.

→ Material of the cylinder block is → cast iron
→ Aluminium alloy.

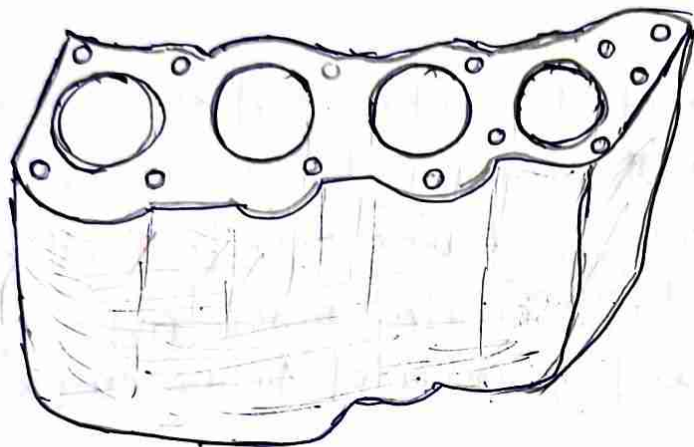

Valve :- Valve are generally mushroom shaped poppet type. It consists of head, a stem, and spring-retainer lock, tip. These are provided either on the cylinder head or on the side of the cylinder for regulating the charge coming into the cylinder. These are basically in an automobile engine two types (i) Inlet valve (ii) Exhaust valve.

Inlet valve is used for → suction the fresh charges or fresh ^{Air} Exhaust valve is used for → escape the burnt gases from inside the cylinder.

Generally inlet valve are generally larger in size, than the exhaust valve, because speed of incoming air-fuel mixture is less than the velocity of exhaust gases which leave under pressure.

Inlet valve → Chromium, silicon-chrome steel.

Exhaust valve → austenitic steels and hardening steel, austenitic steel

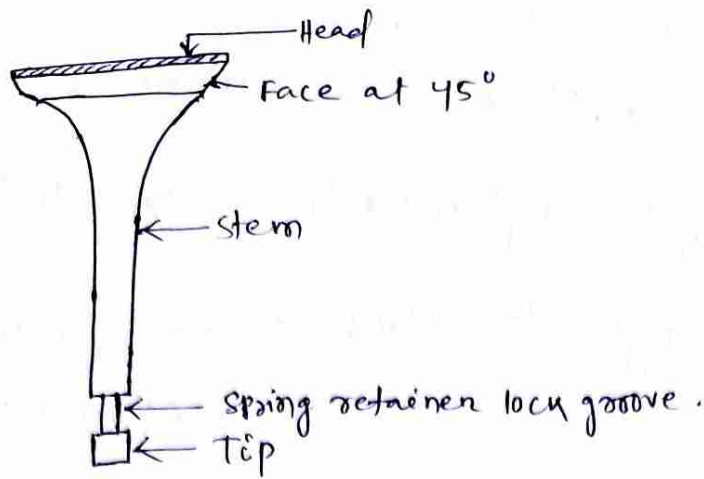

Connecting rod: - It connects the piston and the crank shaft and transmit the gas forces from the piston to the crank shaft. The two ends of the connecting rod are called small end and other is big end. Small end is connected to the piston by ~~rod~~ gudgeon pin and the big end is connected to the crank shaft by crank pin.

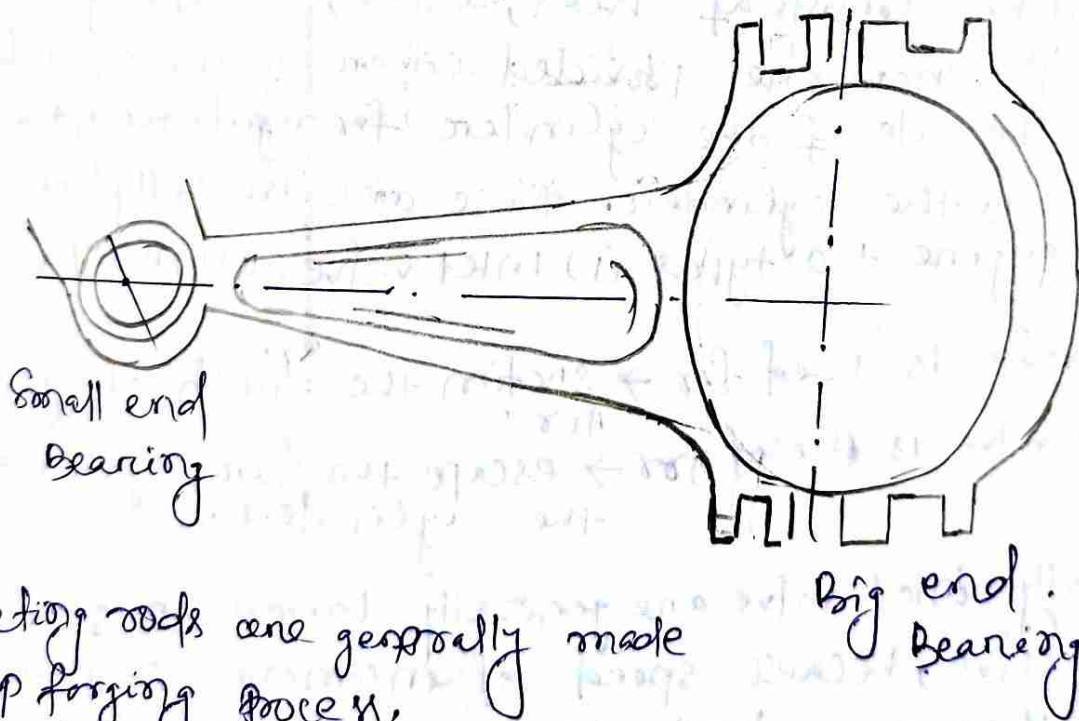

Connecting rods are generally made by drop forging process, material used for connecting rod \rightarrow forged steel or duralumin now days malleable or spheroidal graphite cast-iron.

Crank shaft: - It converts the reciprocating motion of the piston into useful rotary motion of the output shaft. The crankshaft is made of forged steel. The main parts of the crankshaft are journals, crankpins, webs or cranks. The journals rotate in the main bearings. The crankpins rotate in the big end bearings of the connecting rod. The webs join the journals to the crank pin. They serve as balance weight. Crankshaft is enclosed in a crankcase.

Material \rightarrow steels for forged crankshaft.
Manufacturing process \rightarrow casting or forging of heat treated alloy steel.

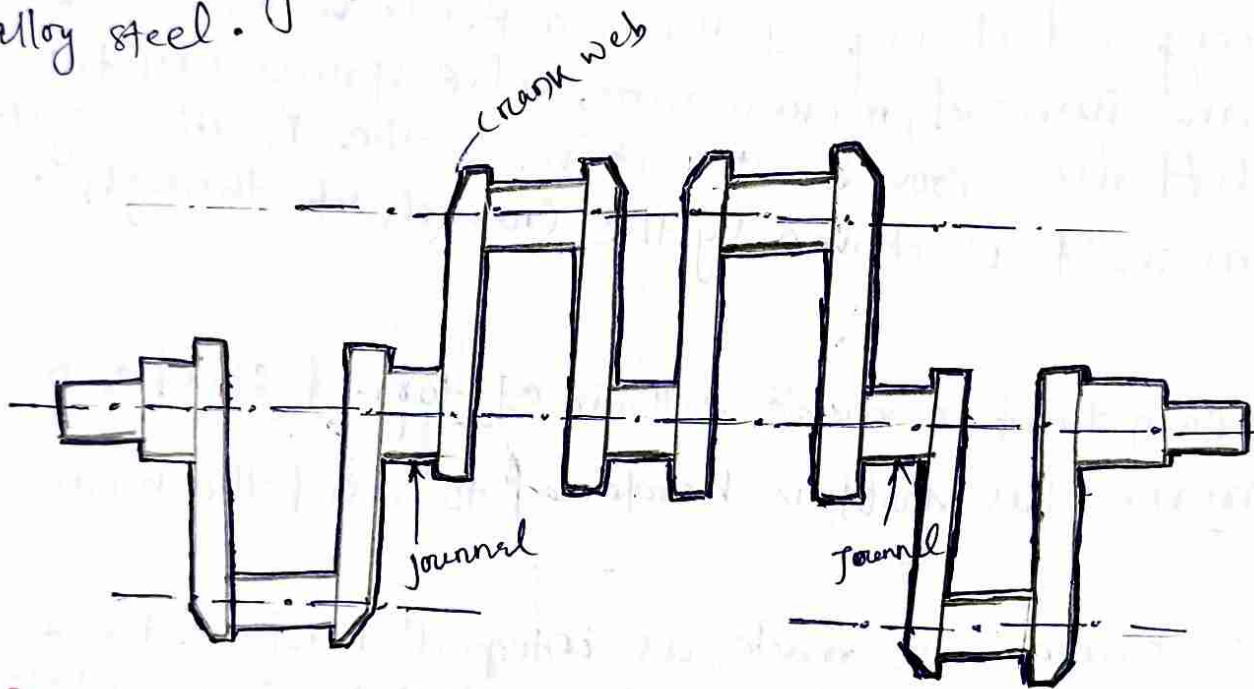

Piston ring

Piston rings fitted into the slots around the piston provide a tight seal between the piston and the cylinder wall thus preventing leakage of combustion gases from the combustion chamber. There are two types of piston rings namely compression ring and oil ring. Compression rings are made of cast iron. Diameter of a compression ring is slightly greater than that of the cylinder bore.

Oil rings, as the piston moves up and down. It rubs against the cylinder wall. This causes scratches on the piston and cylinder wall. To prevent the rubbing action, oil is splashed from an oil pan on to the cylinder wall, when the piston moves up. When the piston moves down, the oil rings scrape the oil from the cylinder wall. Thus the oil falls into the oil pan.

Gudgeon Pin → It forms the link betⁿ the small end of the connecting rod ^{and} the piston.

Cam shaft: → The cam shaft and its associated parts control the opening and closing of the two ~~ports~~ valves. The associated parts are push rod, rocker arm, valve springs and tappets. This shaft also provides the drive to the ignition system. The cam shaft is driven by the crankshaft through timing gear.

→ The cam shaft is made either of forged steel or of cast iron. This shaft is hardened to resist the wear.

Cams: - These are made as integral parts of the cam-shaft and are designed in such a way to open and close the valve at the correct timing and to keep them open and close for the necessary duration.

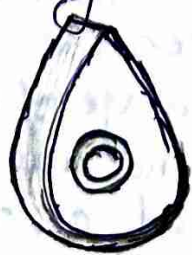

Combustion chamber: - The space enclosed in the upper part of the cylinder by cylinder head and the piston top during the combustion process, is called the combustion chamber. The combustion of fuel and the consequent release of thermal energy results in the building up of pressure in this part of the cylinder.

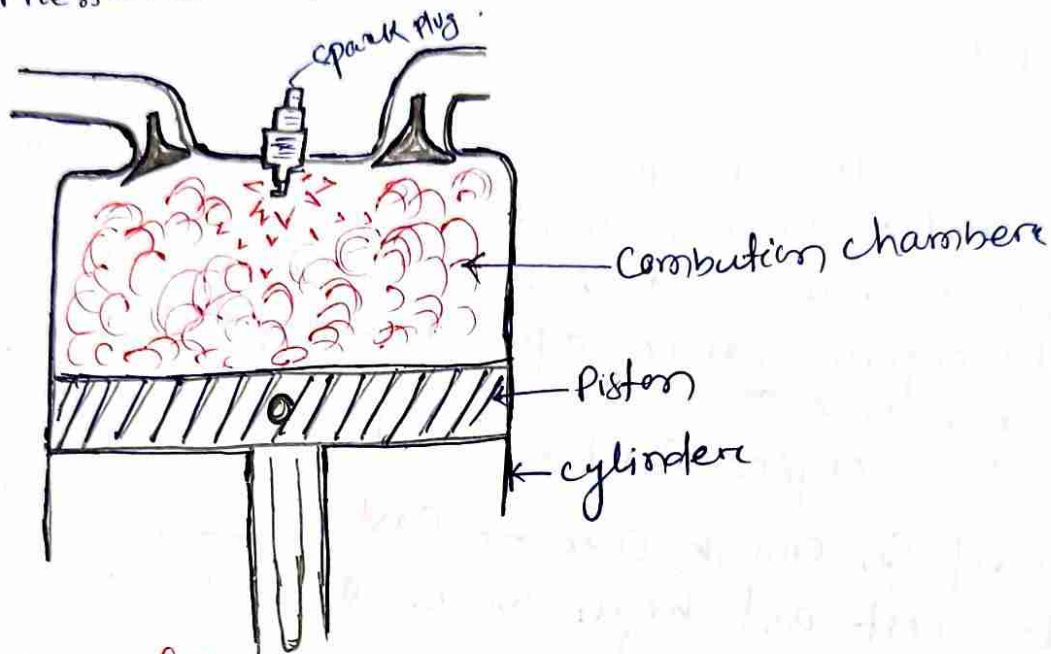

Cylinder liner :- The cylinder liner is a sleeve in which the piston of an engine reciprocates. The life of a cylinder betⁿ its re-bores depends on two main factors (i) Abrasion (ii) Corrosion.

The cylinder liners undergoes wear due to the movement of the piston against its walls. In order to prevent the cylinder from wearing (and also called cylinder sleeve), this is inserted into each cylinder which can be replaced when it is worn out. These are cast centrifugally in the shape of barrel using a special cast iron alloy.

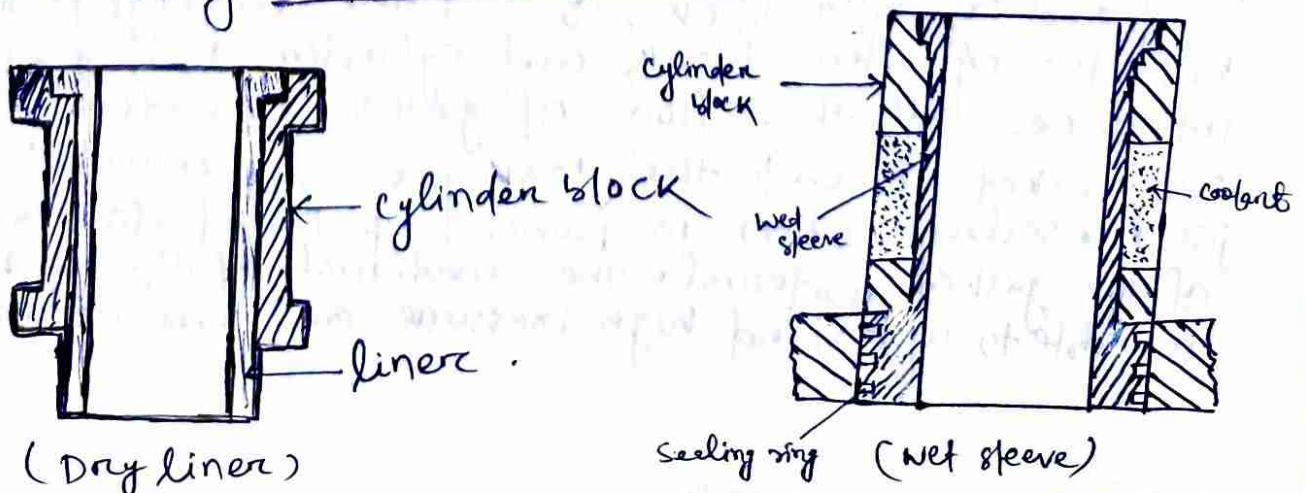

Cylinder Head:- The cylinder head is mounted on the top of the cylinder block and together with the pistons, it encloses the engine's combustion chamber. It is subjected to high temps and pressures. And it is the passages for the circulation of cool water. They support the valves, springs and the rocker gear. The head contains the combustion chamber and possesses the inlet and exhaust port.

Crank Case:- The crank case supports the cylinders and the crankshaft and is an important structure in the internal combustion engine. It is also functions like a housing and protects the engine parts against dust, water and splashing mud. The crankcase stores lubricating oil, required for lubricating the engine parts.

material used for crank case \rightarrow Cast Iron, because it has rigidity, low cost and high wear resistance.

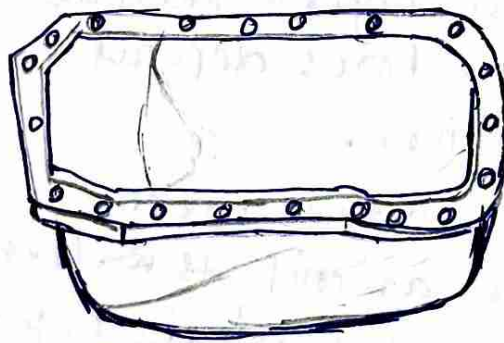

Crank Case.

Gaskets:- The gasket is a piece of soft sheet or spongy sheet having similar holes and cuts as in the cylinder head and cylinder block so that the packing (gasket) placed betⁿ the cylinder block and cylinder head does not interface with the flow of gases or water or both passed. The gasket prevents the leakages and ensure tight fit joints. Sealing action is provided by the elastic deformation of the gasket material. The material of the gasket must be able to withstand high pressure and temperature.

Material \rightarrow used for gaskets are

- (i) Copper - asbestos
- (ii) steel - asbestos
- (iii) stainless steel gasket
- (iv) Cook gasket
- (v) Rubber gasket

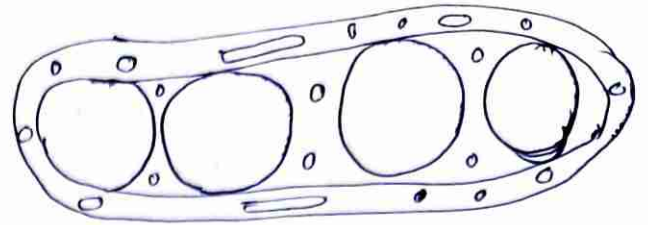

Manifolds: - The manifolds are the complex tubes or passage through which the gases go in and out of the engine. There are two types of manifolds, i.e. intake manifold and exhaust manifold. These are used ~~for~~ as combined unit or separate unit. These are attached to the inlet and exhaust ports of the cylinder head in case of overhead valve engines and cylinder block in case of side valve engine.

The intake manifold provides passage for the flow of air-fuel mixture from the carburettor to the inlet ports of the engine. The exhaust manifold provides passage for the out flow of burnt gases from the exhaust port to the exhaust pipe.

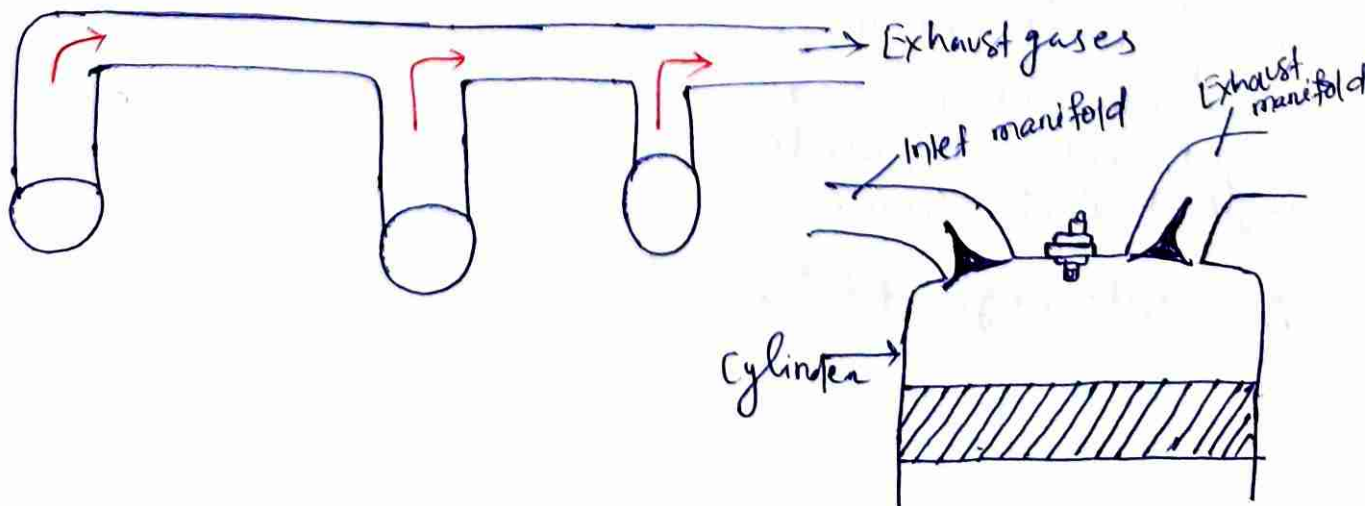
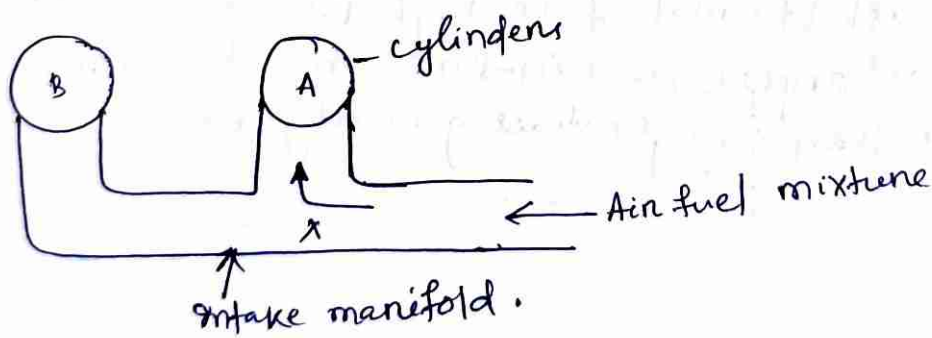

1.3 Cylinder arrangements: Inline Engine and V-Type Engine, firing order of Multicylinder Engine.

Inline Engine: - In in-line engines, all the engines are arranged in one straight line forming one bank. The inline engine is an engine with one cylinder bank i.e. all the cylinders are arranged linearly, and transmit power to a single crankshaft. These are the common with automobile engines. Four and six cylinder engines are very popular in automotive application.

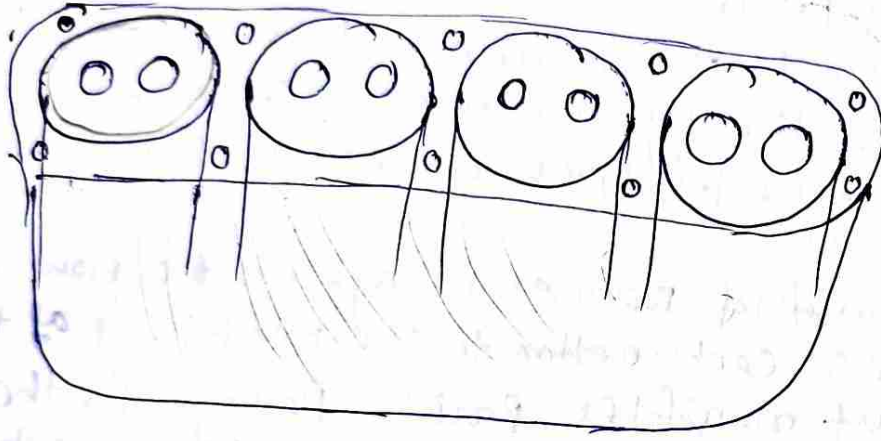

V-Engine: - In this engine there are two banks of cylinder (i.e. two in inline engines) inclined at an angle to each other and with one crankshaft. Most of the high powered automobiles use the 8-cylinder "V" engine, four in-line on each side of the "V". Engines with more than six cylinders generally employ this configuration.

V-Shape engine
the cylinders are placed in two banks set at either right angle or an acute angle to each other.

An acute angle of 60° .

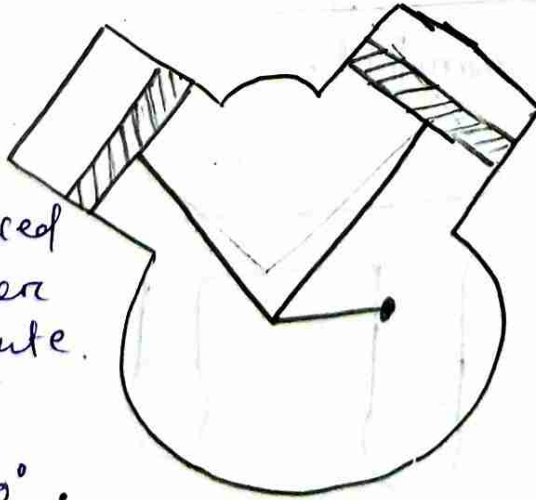

Firing order of Multicylinder engine:-

The sequence in which the power impulses (or power delivery) occur in a multicylinder engine is called firing order. This firing order is a part of the engine design i.e. order in which the cylinders deliver their power strokes. For example, the firing order for a four cylinder engine is given as 1-3-4-2. This means that the firing takes place in the sequence of first-third-fourth and second cylinder respectively.

1-3-4-2
or 1-2-4-3

For six cylinder

1-5-3-6-2-4
1-4-2-6-3-5

For Eight cylinder

1-6-2-5-8-3-7-4
or 1-7-3-8-4-6-2-5
or 1-5-2-6-4-8-3-7

1.4 Side valve actuating mechanism and over head valve actuating mechanism.

Valve Mechanism:- A valve mechanism is a control system which is used for filling the combustible charges i.e. air and fuel mixture in a petrol engine, and only air in a diesel engine. It is also used for the removal of the products of combustion at the correct ~~things~~ timing. In case of two stroke engines, the valve gear mechanism is not used because in these engines, the ports are opened and closed by the moving piston. In four stroke engines, different valve mechanism can be used.

Overhead valve Mechanism :- This type of mechanism, ~~drives~~ crank shaft drives the cam shaft through timing gears. There are a series of lobes on the cam shaft which control the valve movement. The valve mechanism to operate the valve when it is in the cylinder head (in I- and F- head design).

This type of mechanism requires two additional moving parts - the push rod and the rocker arm. As the cam rotates, it lifts the valve-tappet as the lifter which actuates the push rod. The push rod rotates the rocker arm about a shaft the rocker-arm shaft, as a ball joint in some designs, to cause one end to push down on the valve stem to open the valve, thus connecting the valve port with the combustion chamber.

In this mechanism, the valve tappet clearance is between the rocker arm and valve stem. It is adjusted by means of an adjusting screw on the rocker-arm end that contacts the push rod.

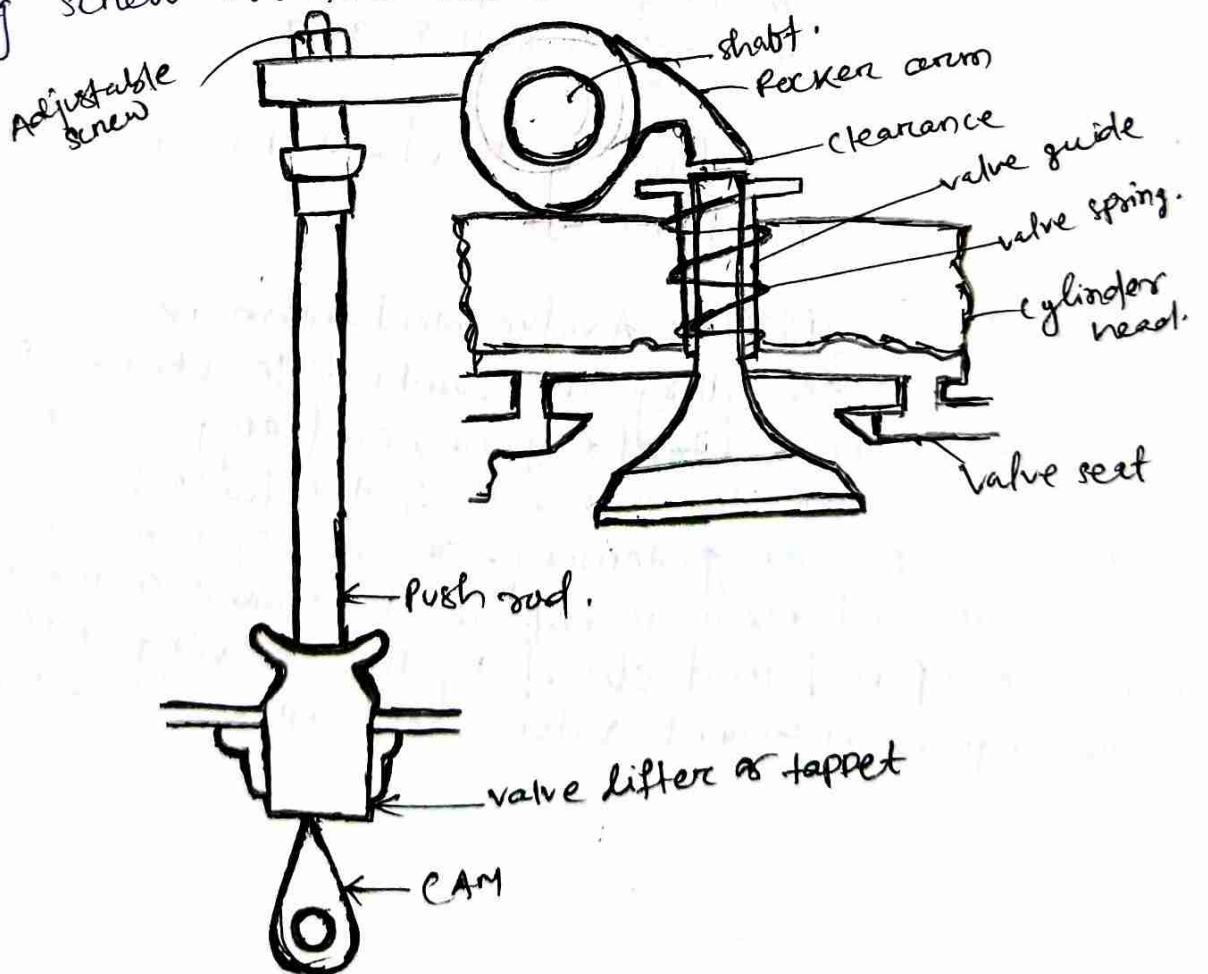

Straight Poppet valve Mechanism

The valve mechanism to operate the valve when it is in the engine block (in L-T and F-head) design. The valve stem slides up and down in the valve stem guide which acts as a slipper bearing. It also prevents the gases from passing from the valve port to the valve chamber of the engine block. Valve springs are fitted between the engine block and spring retainers, which keeps the valve closed tightly on the valve seat, until lifted by the valve tappet by the rotation of the cam. The tappet or lifter is held between guide which is generally a part of the engine block. The adjusting screw is provided on the tappet to adjust the clearance between the upper end of the tappet and the valve stem. As the cam rotates, it lifts the tappet which lifts the valve to the open position, thus connecting the valve port to the combustion chamber.

⇒ Basically these type of mechanisms are used in exhaust valve system only.

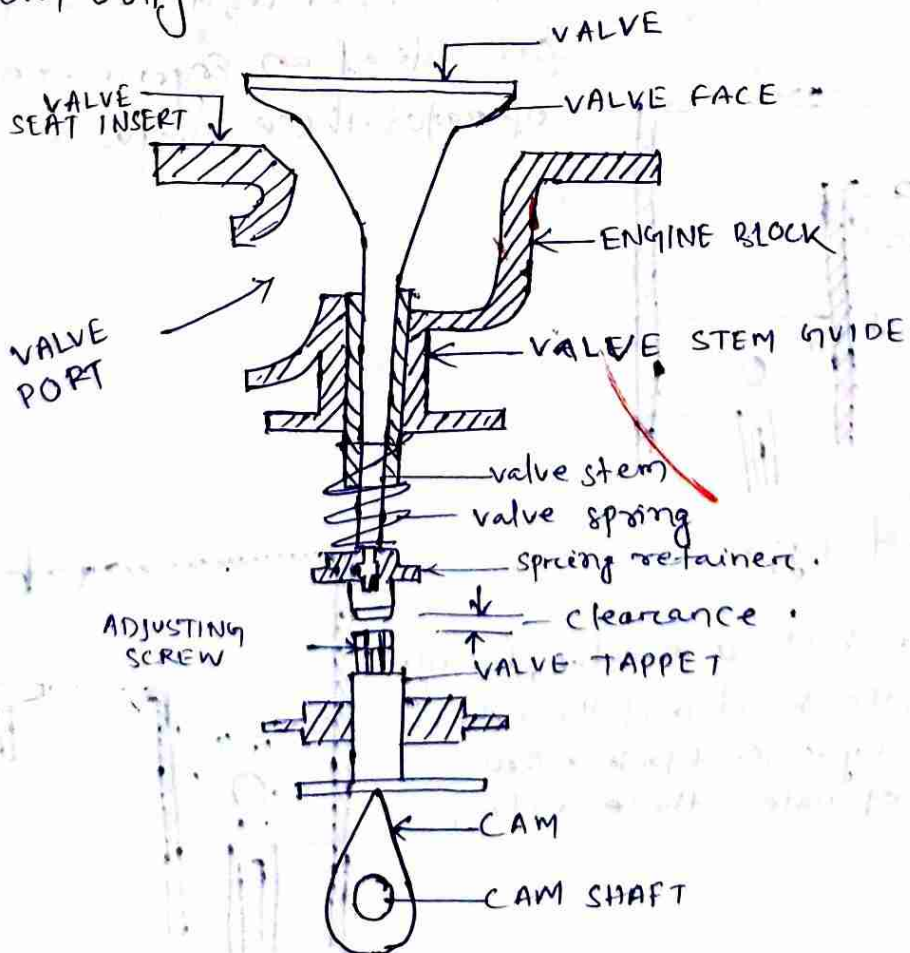

1.5 I F and T Type Valve arrangement, valve clearance.

Internal combustion engines are classified by the design of shape into I-head, L-head, F-head and T-head Engines.

I-Head Type

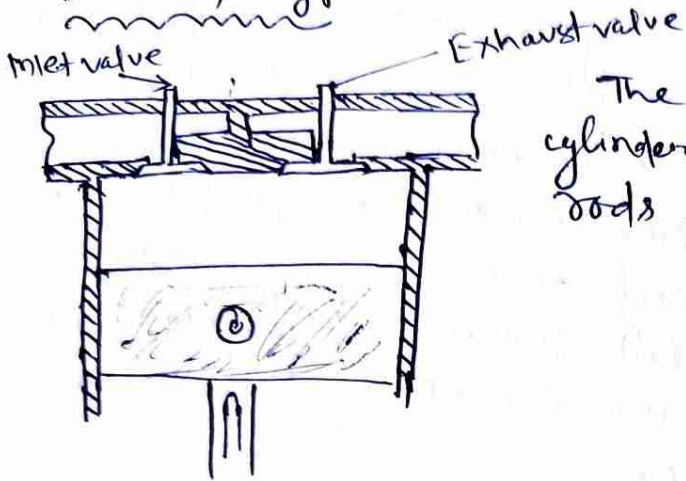

The inlet and Exhaust valves are in the cylinder head. They are operated by push-rods operating rocker arms.

L-Head Type :-

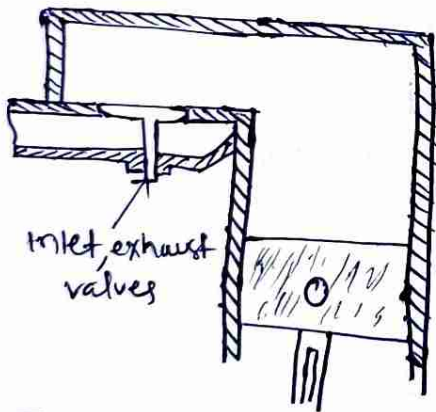

The inlet and Exhaust valves are on one side of an engine. A single cam shaft operates these valves.

F-Head Type

The engine has one valve, usually the inlet in the head and the exhaust valve in the cylinder block. one cam shaft operates these valves.

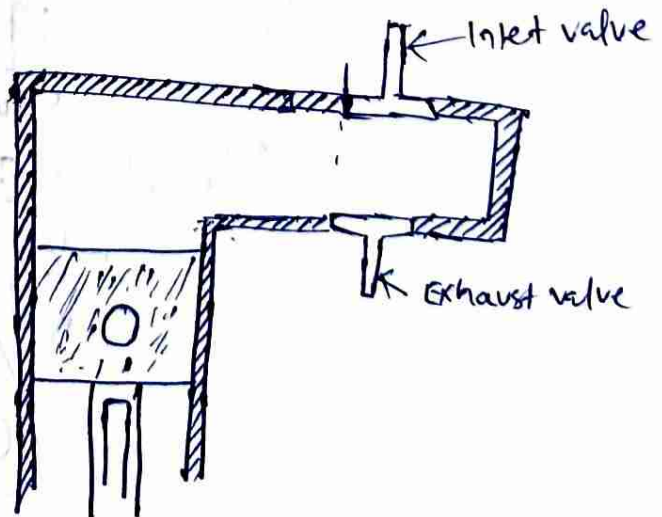

T-Head Type

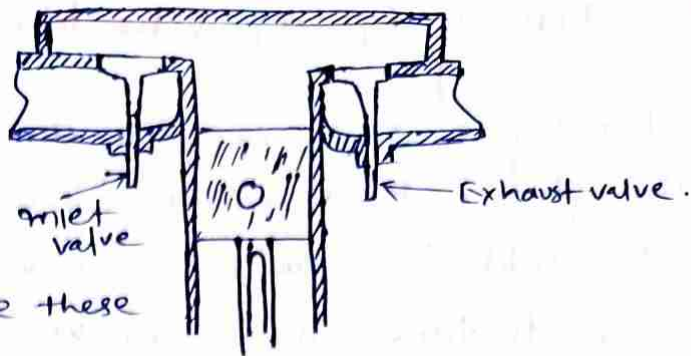

The inlet valves are on one side, the exhaust valves on the other side. Two camshafts operate these valves.

Valve clearance

During the engine operation, heat from the combustion chamber causes the valves stem to expand and becomes longer. without valve clearance, this change in the valve stem lengths would prevent the valve from closing properly. The clearances are incorporated betⁿ the rocker arms and valve stems.

The excessive valve clearance can causes an increase in tappet noise (i.e. the noise made as the cams knock against the valve stems or rocker arms).

Excessive small valve clearance, cause the valves to be pressed down (i.e. open) at all times.

- (i) The clearance betⁿ the rocker arm and valve stem
- (ii) The clearance adjustment betⁿ cam and rocker arm.

1.6 Timing Gears, Vibration Damper

Timing Gear: These are the gears or sprockets and chains through which drive is given from the crankshaft to the cam shaft to allow the intake and exhaust valves to open at the appropriate time. These are known as timing gears or sprockets and chains as they case may be, because these set the timing of the engine. It may be noted that one each gear or sprocket is fitted at the crankshaft and camshaft.

The movement of the piston which is affected by the rotation of the crankshaft, is directly related to the opening and closing of the valve affected by the rotation of camshaft. Their relationship is set up by fixing camshaft gear or sprocket chain with the crankshaft gear or sprocket. This is also known as sprocket.

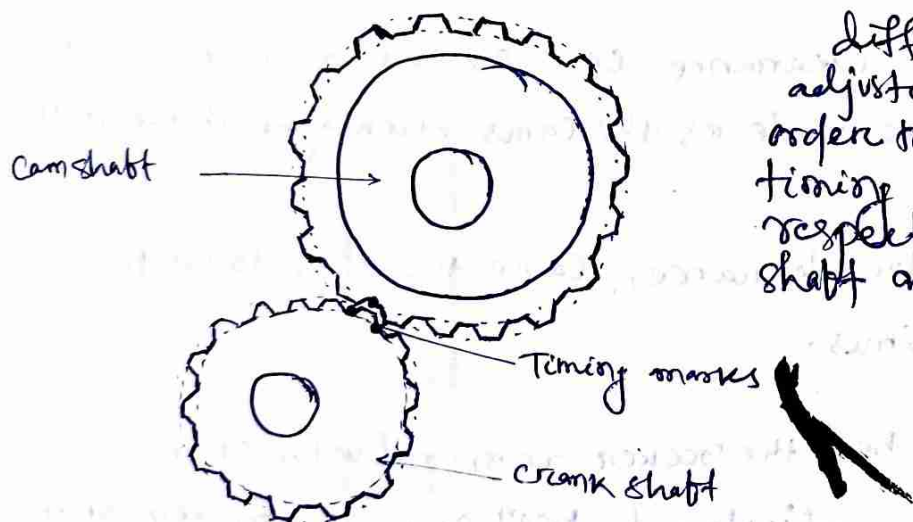

• There may be some difficulties in correctly adjusting the valve timing. In order to avoid the difficulties, timing marks are made on the respective gears of the camshaft and the crankshaft.

Vibration Damper

During the power stroke of each cycle, force is developed inside the engine cylinder. This force acts directly on the crankpin and the crankshaft is twisted by this force. When the cycle is completed the crankshaft is untwisted. Thus the crankshaft is twisted and untwisted for each cycle operation. This twisting and untwisting develop the torsional vibration and if the frequency of oscillations of these vibrations becomes equal to the natural frequency of the crankshaft, the crankshaft breaks.

- A vibration damper or harmonic balancer is fitted to the front end of the crank shaft, in order to minimize the vibration.
- The vibration damper consists of a damper flywheel with the crankshaft flange and the driving flange.
- There is a rubber ring in betⁿ the damper flywheel and the driving flange.
- When the crankshaft rotates, torsional vibrations are developed but vibration damper reduces these vibrations.
- This damping of vibration takes place due to the dragging effect produced by the inertia of the damper flywheel.
- The rubber ring is flexed due to the effect and thus the crankshaft speed is maintained uniformly.

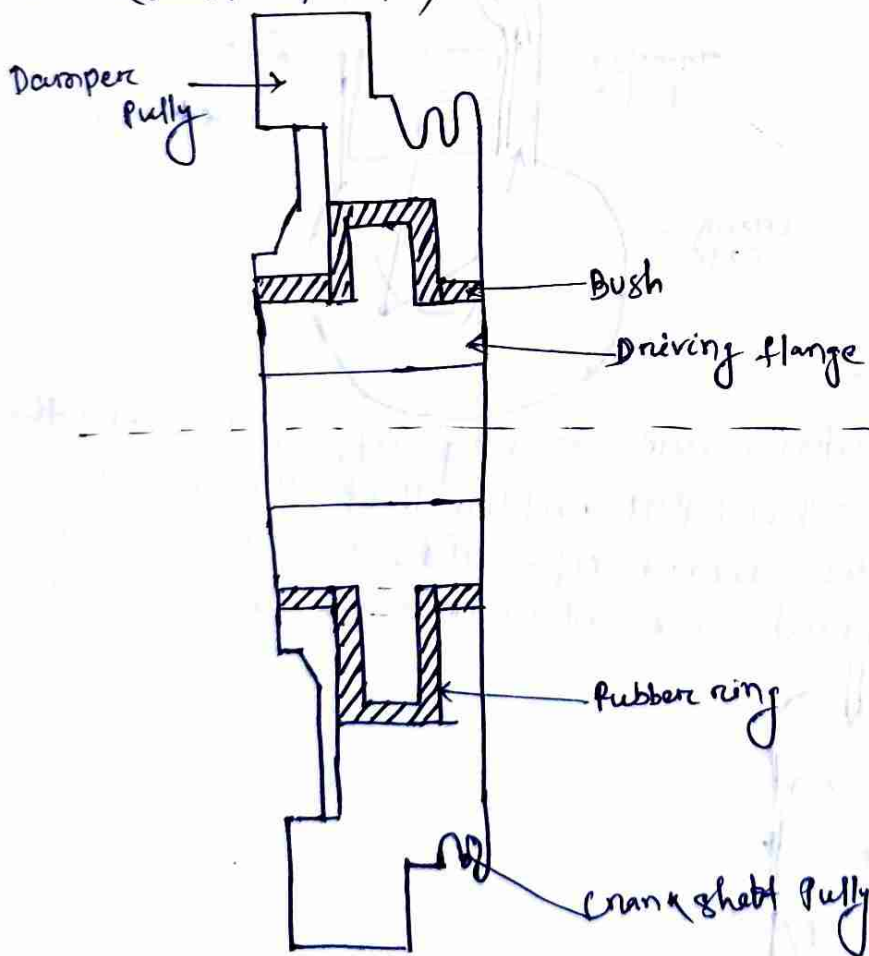

② Diesel Engine and its Constructional details

2.1 Working Principle two strokes and four stroke diesel Engine.

TWO-STROKE CYCLE DIESEL ENGINE

A two-stroke cycle diesel engine also has one working stroke after every revolution of the crank shaft. All the four stages of a two-stroke cycle diesel engine are described.

① Intake or suction stage :- In this stage, the piston while going down towards BDC uncovers the transfer port and the exhaust port. The fresh air flows into the engine cylinder from the crank case.

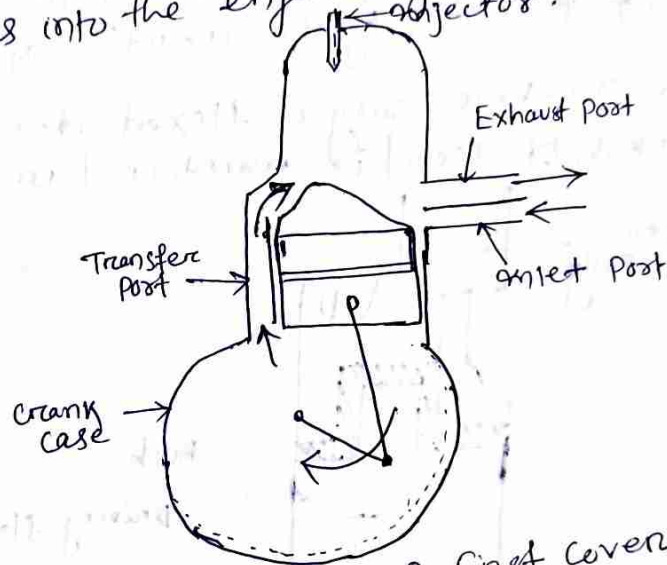

② Compression stage :-

In this stage the piston while moving up, first covers the transfer port and then exhaust port. After that the air is compressed as the piston moves upwards, at this stage, the inlet port opens and fresh air enters into the crank case.

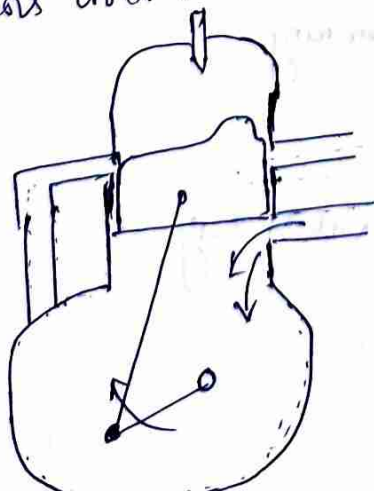

③ Expansion stage:- shortly before the piston reaches the TDC (during compression stroke), the fuel is injected in the form of very fine spray into the engine cylinder through the nozzle known as fuel injector. At that moment temp^s of the fuel compressed air is sufficiently high to ignite the fuel. It increases the pressure and temp^s of the products of combustion. The fuel is continuously injected for a fraction of the crank revolution. The fuel is assumed to be burnt at constant pressure. Due to increased pressure, the piston is pushed with a great force. The hot burnt gases expand due to high speed of the piston. During the expansion some of heat energy produced is transferred into mechanical work.

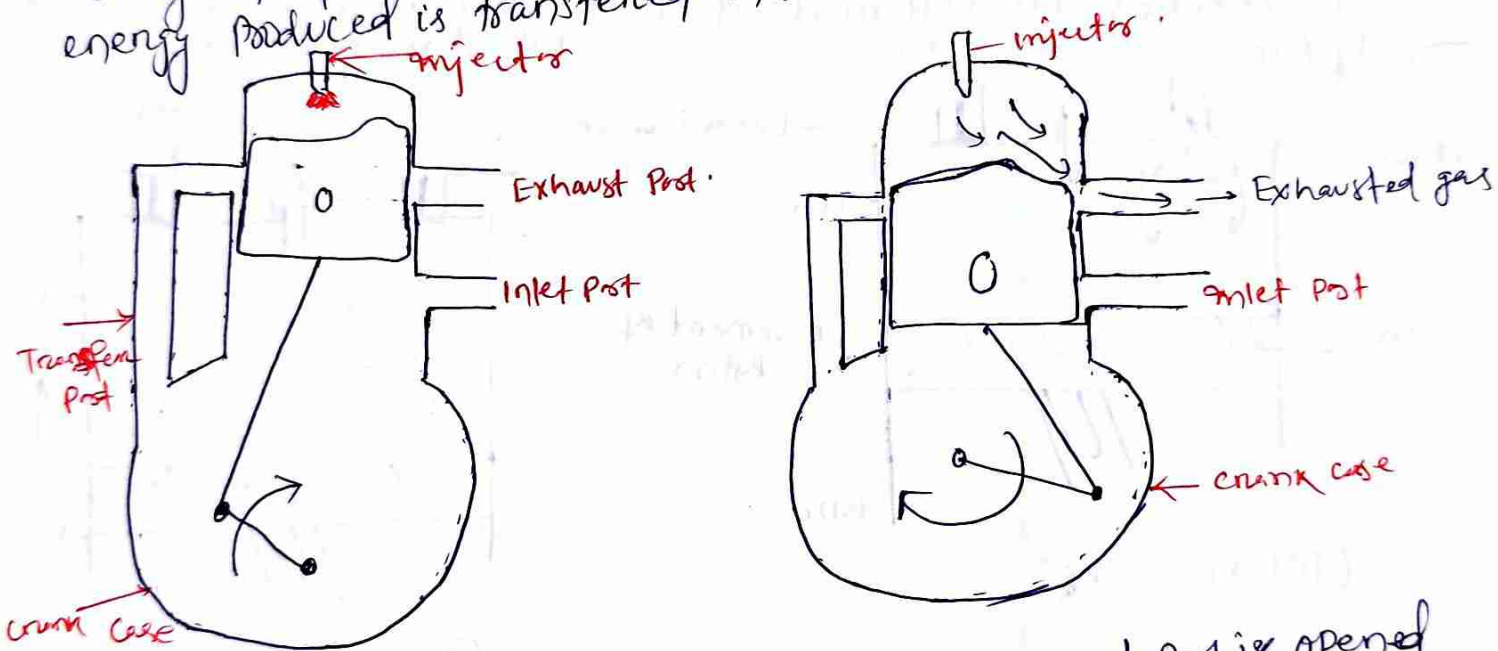

④ Exhaust stage:- In this stage, the exhaust port is opened and the piston moves downwards. The products of combustion from the engine cylinder are exhausted through the port into the atmosphere. This completes cycle, and the engine cylinder is ready to suck the air again.

FOUR STROKE DIESEL ENGINE

It is also known as compression ignition engine (C.I) because the ignition takes place due to the heat produced in the engine cylinder at the end of compression stroke. The four strokes of diesel engine sucking pure air only.

Intake or suction stroke:- In this stroke, the inlet valve opens and pure air is sucked into the cylinder as the piston moves downwards from the top dead centre (TDC). It continues till the piston reaches its bottom dead centre BDC. Inlet valve opens & Exhaust valve closed.

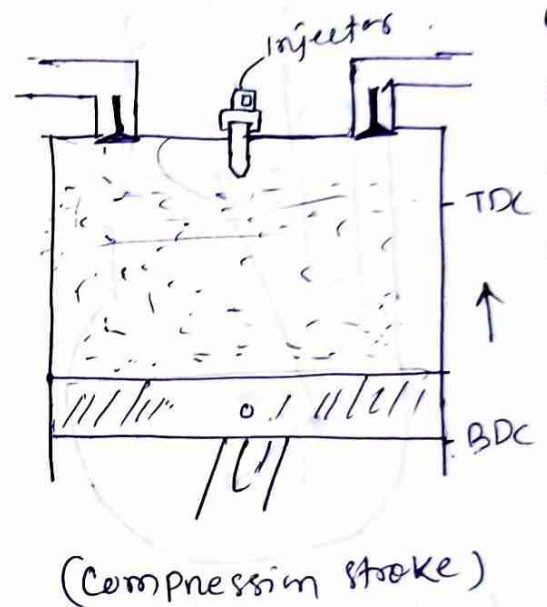
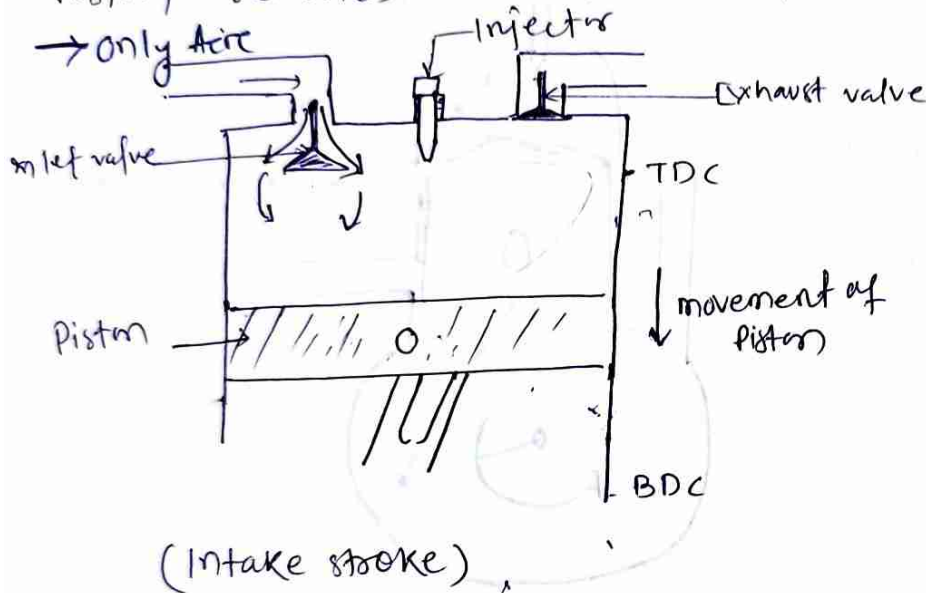

Compression stroke:- In this stroke, both the valves are closed & the air is compressed as the piston moves upward from BDC to TDC. As a result of compression, pressure and temp^o of the air is ~~increased~~ increases considerably.

Expansion stroke:- Shortly before the piston reaches the TDC (during the compression stroke), fuel is injected in the form of very fine spray into the engine cylinder, through the nozzle known as fuel injector. At that moment temp^o of the compressed air is sufficiently high to ignite the fuel. Due to increase of pressure the piston is pushed down with great force and piston moves from TDC to BDC, both valves remain close in this stroke.

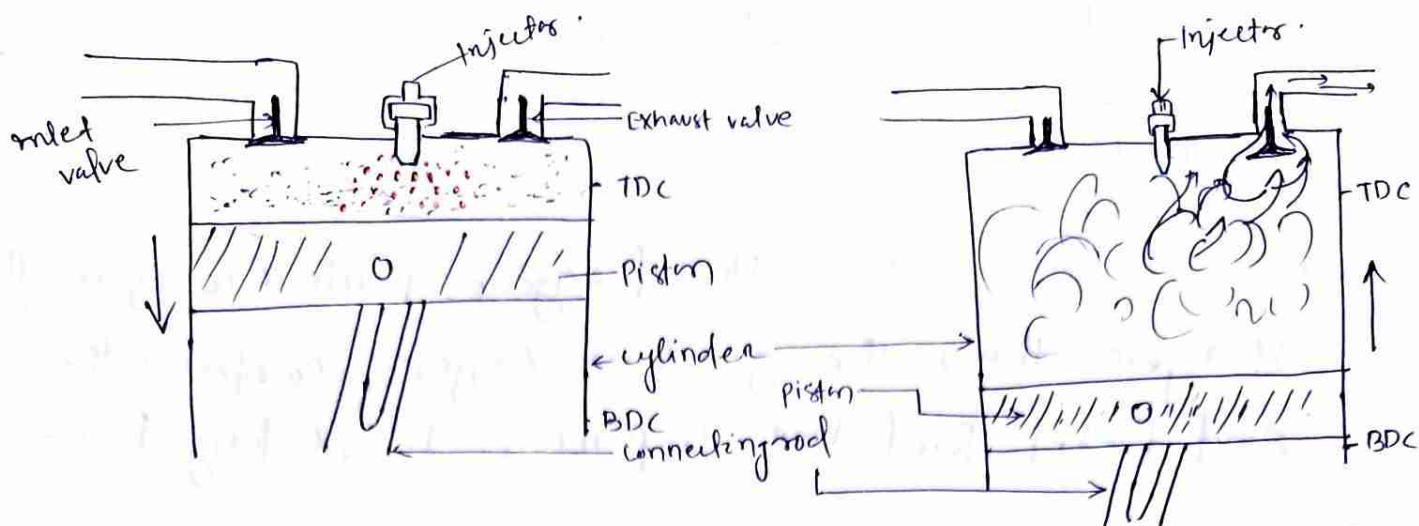

Exhaust stroke: - In this stroke the exhaust valve is open as the piston moves from BDC to TDC. This movement of the piston pushes out the products of combustion from the engine cylinder through the exhaust valve into the atmosphere. This completes the cycle and engine cylinder is ready to suck fresh air again.

2.2 Types, Advantages & limitations of diesel engine over petrol engine:

1. Diesel are more efficient :- Most of gasoline engines convert about 30 percent of their fuel energy into actual power. A traditional diesel converts about 40%. And advanced diesel engine can hit about 50%.
2. Diesels are more reliable :- Because they don't need high voltage ignition systems, diesel engines never fail for lack of a spark. They also don't emit radio frequency emissions that can interfere with a vehicles other electronic systems.

3. Diesels run cooler:- Because they are more efficient, diesel engines release less waste heat while in operation.
4. Diesels last longer:- Diesel engine parts are generally stronger than the gasoline engine components. and diesel fuel has superior lubricating properties.
- 5 Diesel fuel is safer:- Diesel fuel does not release fumes like gasoline does. It is more difficult to burn and won't explode like lighter counterpart.
- (6): Diesels produce minimal carbon monoxide:- This makes diesel generators useful in mines and submarines, environment in which gasoline engine exhaust would prove deadly.
- (7) Diesels are more easily turbo-charged: Put under sufficient pressure, gasoline engines will spontaneously detonate.

2.3 Function & types of Combustion chamber

function:- The space enclosed in the upper part of the cylinder by the cylinder head and the piston top during the combustion process, is called combustion chamber. The combustion of fuel and consequent release of thermal energy results in the building up of pressure in this part of the cylinder.

Types of Combustion chamber

There are two types of combustion chamber, (i) Direct injection type and the indirect injection type.

2.4 Direct Injection Combustion chamber :- This type of combustion chamber is also called an open combustion chamber. In this type the entire volume of the combustion chamber is located in the main cylinder and the fuel is injected into this volume. These are (a) shallow depth chamber (b) Hemi-spherical chamber (c) cylindrical chamber (d) Toroidal chamber

Shallow Depth :- The shallow depth chamber, there is a shallow cavity in the piston. This type of chamber is usually adopted for large engines at low speed, the squish produced is very little in this case.

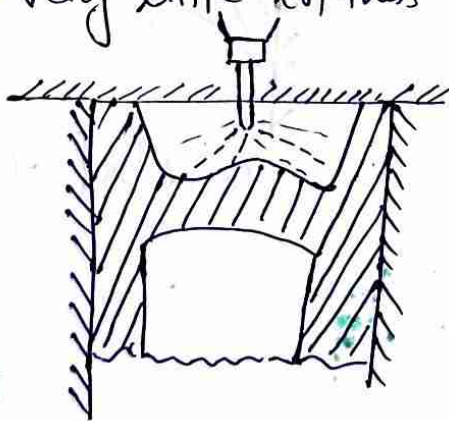

Shallow depth

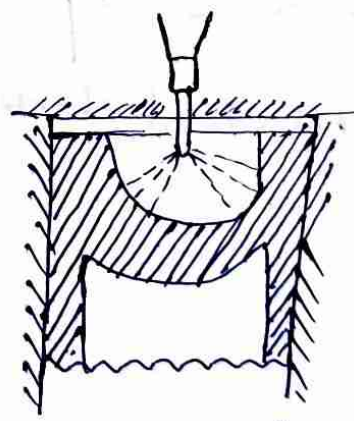

Hemispherical

Hemispherical:- This chamber also gives broad swirl. The depth to diameter ratio for this hemispherical chamber can be varied and the desired swirl can be obtained. Thus the engine performance can also be improved.

Cylindrical:- This design ^{is adopted.} was attempted in recent diesel engines. This is a modification of the cylindrical chamber in the form of a ~~truncated~~ truncated cone with base angle of 30° . The swirl was produced by ~~making~~ changing the depth of the chamber.

Toroidal:- The surface of this chamber is in the form of a toroid. This shape provides a powerful swirl along with the movement of the air. The cone angle of the spray is 150° to 160° .

~~Direct injection~~ (DI)

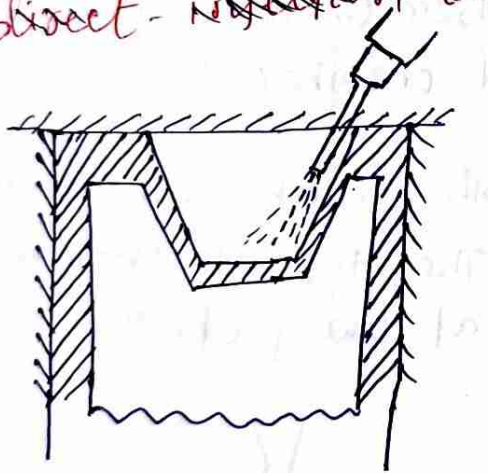

cylindrical chamber

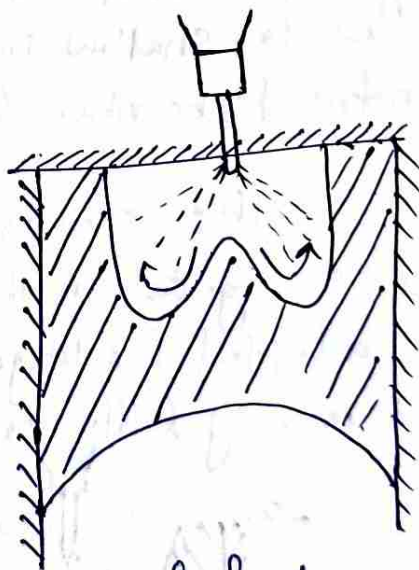

Toroidal chamber

Indirect injection chamber:-

In this type of combustion chamber, the combustion space is divided into two parts, one part in the main ^{cylinder} chamber and the other part in the cylinder head. The fuel injection is affected usually into that part of chamber located in the cylinder head. These chambers are classified further into

- Swirl chamber in which compression swirl is generated
- Pot combustion chamber in which combustion swirl is induced

Swirl chamber:- Swirl chamber consists of a spherical-shaped chamber separated from the engine cylinder.

→ located at the cylinder head.

→ In this chamber, about 50% of the air is transferred during the ^{end of} suction stroke.

→ A throat is connected the chamber and the cylinder head which enters the chamber in a tangential direction.

→ So that the air coming into this chamber is given a strong rotary movement inside the swirl chamber and after combustion

→ the rush back into the cylinder through the same throat at much higher velocity.

→ These chambers are highly insulated to prevent the heat loss to the walls, but greater heat loss than the open combustion chamber.

* This type of combustion chamber finds application where fuel quality is difficult to control

* Reliability under adverse condition is more important than fuel economy.

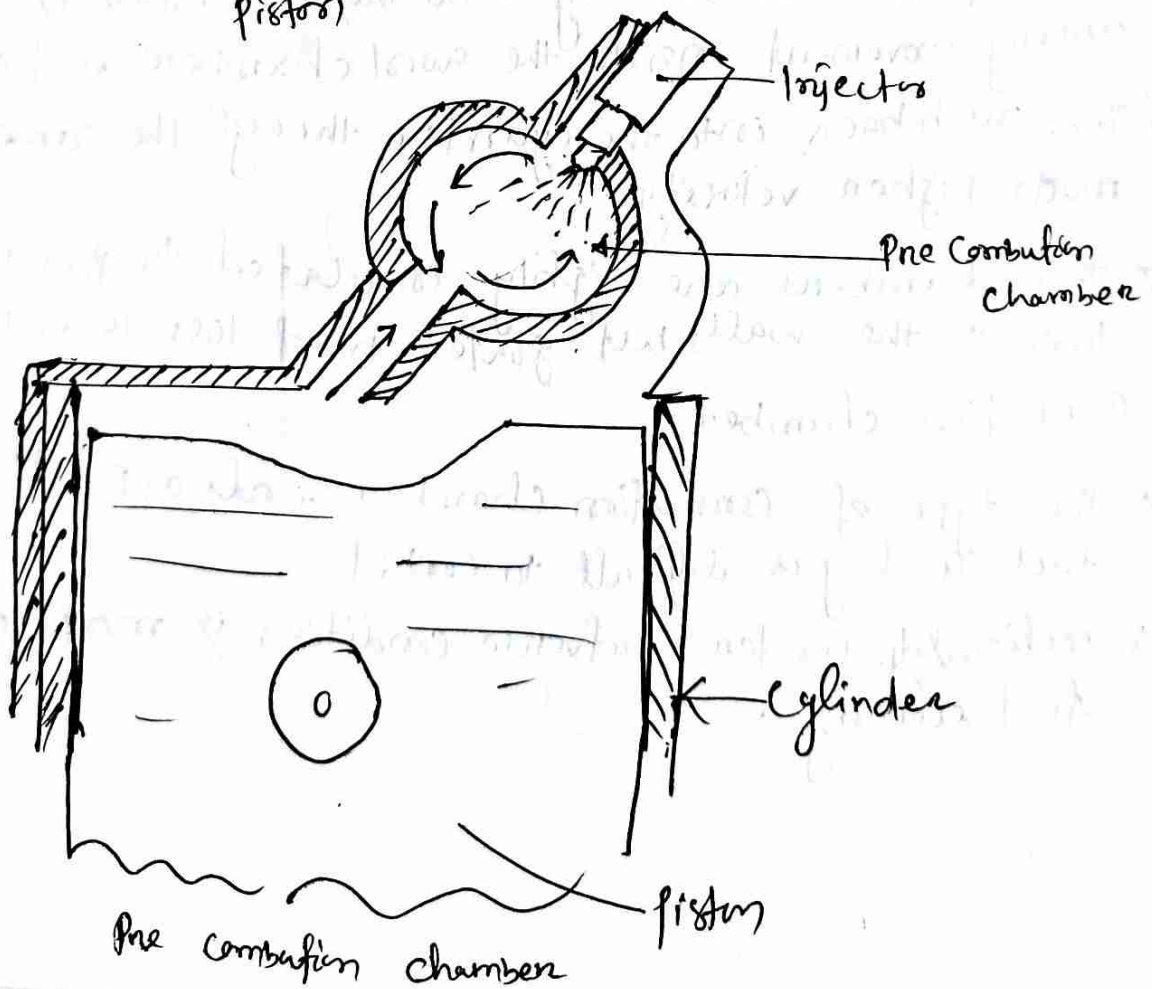
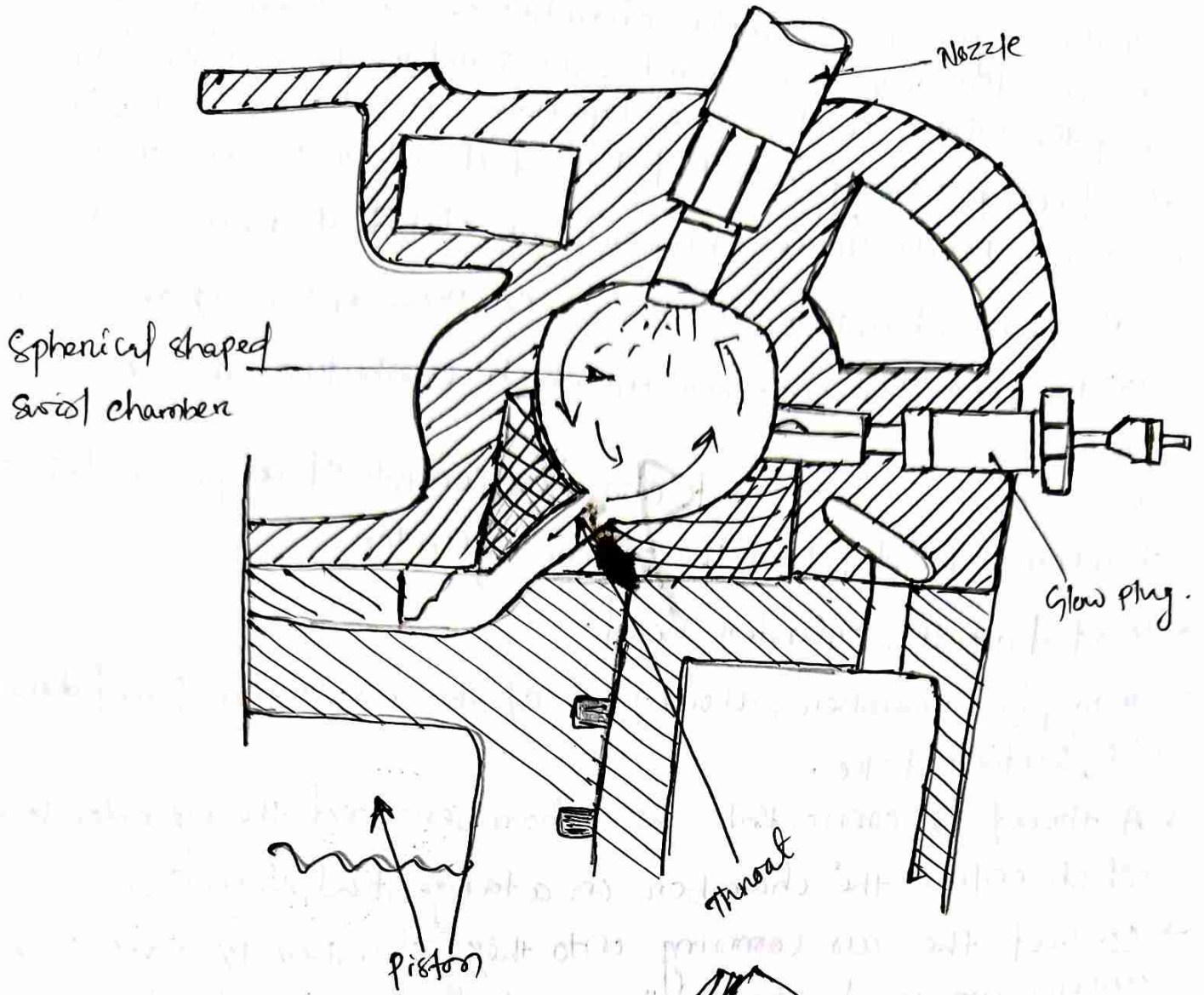

→ In this type of combustion chamber, the combustion chamber is actually divided into two chambers.

→ The smaller chamber also known as Pre-combustion chamber or auxiliary chamber.

→ It occupies about 30% of the total combustion space.

→ The two chambers are connected by the narrow passage & a number of small holes.

→ During the compression stroke, the air is forced into the combustion chamber by the piston.

→ Only a part of the air is contained in the auxiliary chamber and the remaining is kept in the space above the piston in main chamber.

→ The fuel is injected into the pre-combustion chamber.

→ The very rich mixture explodes and throws the unburned fuel into the

→ The fuel starts to burn with an insufficient amount of air.

→ The very rich mixture explodes and throws the unburned fuel into the main chamber through the small passage and creating violent air motion.

→ That violent air motion helps to rapid mixing & burning in the main combustion chamber.

Advantages of Direct injection chamber

(i) Minimum heat loss during the compression

(ii) It provides better efficiency.

(iii) No cold start problem

(iv) Provide fine atomization of fuel particle.

Dis Advantages

(i) Required high injection pressure

(ii) Required complex design of fuel pump.

(iii) Required accurate metering of fuel.

Advantages of Indirect combustion chamber

- (i) Required low injection pressure
- (ii) Direction of spraying is not important
- (iii) Combustion of fuel is better as maximize the burning of fuel.

Disadvantages

- (i) Poor cold starting.
- (ii) Required high maintenance
- (iii) Cost of the system is high.
- (iv) Fuel consumption rate is high.
- (v) Loss of heat is high.

③ Performance of I.C Engine

3.1 Define mechanical efficiency, indicated thermal efficiency, relative efficiency, brake thermal efficiency, and overall efficiency, Mean effective pressure & specific fuel consumption.

Mechanical efficiency: - It is defined as the ratio of brake power (delivered power) to the indicated power (power provided to the piston)

$$\eta_{\text{mech}} = \frac{b.p.}{i.p.} = \frac{b.p.}{b.p. + f.p.} \quad \text{or} \quad \frac{\eta_{\text{bth}}}{\eta_{\text{ith}}}$$

$$f.p. = i.p. - b.p.$$

Indicated thermal efficiency (η_{ith}): - It is defined as the ratio of energy in the indicated power (i.p.) to the input fuel energy in appropriate units.

$$\eta_{\text{ith}} = \frac{i.p. \text{ (KJ/s)}}{\text{energy in fuel per second (KJ/s)}} \\ = \frac{i.p.}{\text{mass of fuel/s} \times \text{calorific value of fuel}}$$

$$\eta_{\text{ith}} = \frac{i.p.}{E}, \quad \eta_{\text{bth}} = \frac{b.p.}{E}, \quad \eta_{\text{m}} = \frac{b.p.}{i.p.}$$

$$E = \text{Energy (E) in fuel [KW]}$$

Relative efficiency: - Relative efficiency or efficiency ratio is the ratio of thermal efficiency of an actual cycle to that of the ideal cycle. The efficiency ratio is very useful criterion which indicates the degree of the development of the engine

$$\eta_{\text{rel}} = \frac{\text{Actual thermal efficiency}}{\text{Air-standard efficiency}}$$

Brake thermal efficiency :- It is the ratio of energy in the brake power (BP) to the input fuel energy in appropriate units.

$$\eta_{bth} = \frac{bp}{\text{mass of fuel/s} \times \text{Calorific value of fuel}}$$

Overall efficiency :- It is the ratio of the mechanical output to the thermal input.

Mean effective pressure :- Mean effective pressure is the average pressure inside the cylinders of an internal combustion engine based on the calculated or measured power-output. It increases as manifold pressure increases.

$$ip = \frac{P_{im} LANK}{60 \times 1000}$$

$$P_{im} = \frac{60000 \times ip}{LANK}$$

ip = indicated power

P_{im} = Indicated mean effective pressure

L = Length of the stroke

A = Area of the piston

N = speed in revolutions per minute (rpm)

n = Number of power strokes

$N/2$ for 4-stroke

N for 2-stroke

K = number of cylinders.

Specific fuel consumption :- It is defined as the amount of fuel consumed per unit of power developed per hour.

$$\text{Specific fuel consumption} :- \frac{\text{fuel consumption in kg/h}}{\text{Power developed}}$$

3.2 Air - fuel ratio & calorific value of fuel.

Air-fuel ratio (A/F) ~~is fuel~~

It is the ratio at which petrol (gasoline) & air are mixed. ~~It is~~ In general this is expressed in terms of weight. The air-fuel ratio is necessary to maintain proper combustion, as it varies with the engine speed, load, temperature and engine design. Theoretically to completely burn 1 gram petrol 14.7 grams of air is needed.

A mixture that contains just enough air for complete combustion of all the fuel in the mixture is called chemically correct or stoichiometric fuel air ratio.

A mixture having more fuel than that in a chemically correct mixture is termed as rich mixture and a mixture that contains less fuel (or excess air) is called a lean mixture.

The ratio of actual air-fuel ratio to stoichiometric fuel-air ratio is called equivalence ratio & denoted by ϕ

$$\phi = \frac{\text{Actual Air-fuel ratio}}{\text{Stoichiometric Air-fuel ratio}}$$

Accordingly $\phi = 1$ means stoichiometric (chemically correct)

$\phi < 1$ means lean mixture

$\phi > 1$ means rich mixture

CALORIFIC VALUE (CV)

Calorific value of a fuel is the thermal energy released per unit quantity of the fuel when the fuel is burned completely and the products of combustion are cooled back to the initial temp of the combustible mixture. Other term of CV is heating value.

Q.8 It is the heat liberated from the burning of fuel when mass of the fuel is 1 kg.

$$C_v = \frac{H \cdot A}{\text{kg of fuel}}$$

$$H A = C_v \times m_f$$

$$\frac{H A}{\text{sec}} = C_v \times \frac{m_f}{\text{sec}}$$

~~Q.9~~ **Friction Power**:- The difference betⁿ the indicated power of an engine and the brake power of an engine is known as friction power. Internal losses in an engine are essentially of two kinds viz - Pumping & frictional losses.

Frictional Power measured by the following methods

(i) Willan's method

(ii) Morse test

(iii) Motoring test

Indicated Power:- Power defined as the rate of doing work. The power output developed inside the engine cylinder is measured by obtaining the P-V diagram with the help of indicator and is called 'indicated power' which is given by me

$$i_p = \frac{IMEP \times L \times A \left(N \text{ or } \frac{N}{2} \right)}{60}$$

Brake Power:- The Power output of an engine is measured with the help of brake or dynamometer & is called brake power or shaft power

$$BP = \frac{2\pi NT}{60}$$

$T =$ is the Torque in Nm
 $N =$ rpm of shaft.

~~A four stroke cylinder gas engine engine~~

3.3 Morse-Test and Preparation of heat balance sheet.

The Morse test can be used to measure the indicated power of multi cylinder engines. The engine, say having four cylinders is run at the required speed and the torque is measured.

→ Now one cylinder is cut out by disconnecting the injector of C.I engine (or by shorting the spark plug of an S.I engine)

→ The speed falls because of the loss of power with one cylinder cut out, but it is restored by reducing the load.

→ When the speed has reduced the original value, the torque again measured.

→ It is repeated by cutting out the other cylinder one by one.

→ If the value of IP of the cylinders are denoted by I_1, I_2, I_3 & I_4 & the power losses by the each cylinder are denoted by L_1, L_2, L_3 & L_4 then the value of BP at the test speed with all cylinders firing is given by

$$B = (I_1 - L_1) + (I_2 - L_2) + (I_3 - L_3) + (I_4 - L_4) \quad \text{--- (1)}$$

If number 1 cylinder is cut, then the contribution I_1 is lost. If the losses due to that cylinder remain the same as when it was firing, then the B.P., B_1 obtained at the same speed is

$$B_1 = (I_1 - L_1) + (I_2 - L_2) + (I_3 - L_3) + (I_4 - L_4) \quad \text{--- (11)}$$

By subtracting Eq. (2) from eq. (1)

$$B - B_1 = I_1$$

By cutting out each cylinder in turn the values of I_2, I_3 & I_4 can be similarly obtained. Therefore, the total indicated power of the engine is

$$I = I_1 + I_2 + I_3 + I_4$$

3.4:- Work out problems to determine efficiency & specific fuel consumption.

A four-cylinder four-stroke gasoline engine has a 65 mm diameter and 95 mm stroke. On test, it developed a torque of 64 Nm when running at 3000 rpm. If the clearance volume in each cylinder is 63 cm³, the brake efficiency ratio based on air standard efficiency is 0.5 & calorific value of gasoline is 42 MJ/kg, determine the fuel consumption in kg/h and the bmep.

Solⁿ swept volume per cylinder V_s

$$= \frac{\pi}{4} d^2 L = \frac{\pi}{4} (6.5)^2 \times 9.5 = 315.24 \text{ cm}^3$$

$$\pi = \frac{V_s + V_c}{V_c} = \frac{315.24 + 63}{63} = 6$$

$$\text{Air standard efficiency } \eta_{air} = 1 - \frac{1}{(r)^{\gamma-1}} = 1 - \frac{1}{6^{0.4}} = 0.5125$$

$$\text{Relative efficiency} = \frac{\text{Brake thermal efficiency}}{\text{Air standard efficiency}} = 0.5$$

$$\text{Brake thermal efficiency} = 0.5 \times 0.5125 = 0.2562$$

$$BP = \frac{2\pi NT}{60} = \frac{2\pi \times 3000 \times 64}{60 \times 1000} = 20.1 \text{ kW}$$

$$\eta_{br.th} = \frac{BP}{\dot{m}_f \times CV} = \frac{20.1}{\dot{m}_f \times 42000} = 0.2562$$

$$\dot{m}_f = \frac{20.1 \times 3600}{0.2562 \times 42000} = 6.726 \text{ kg/h}$$

$$BP = \frac{BMEP \frac{\pi D^2 L N}{4}}{60 \times 2}$$

$$BMEP =$$

Q A four-cylinder two-stroke cycle petrol engine develops 30 kW at 2500 rpm. The mean effective pressure of each 800 kN/m² and mechanical efficiency is 80%. Calculate the diameter & stroke of each cylinder if the stroke-to-bore ratio is 1.5. Also calculate the brake specific fuel consumption of the engine, if brake thermal is 28%. The heating value of petrol is 44 MJ/kg.

$$\text{No. of cylinders} = 4, \text{ B.P.} = 30 \text{ kW}$$

$$N = 2500 \text{ RPM}, P_m = 800 \text{ kN/m}^2, \eta_{\text{mech}} = 80$$

$$L/d = 1.5 \quad \eta_{\text{bth}} = 28\%, \quad C_v = 44 \text{ MJ/kg}$$

$$\dot{I}_p = \frac{\text{BP}}{\eta_{\text{mech}}} = \frac{30}{0.8} = 37.5 \text{ kW}$$

$$\dot{I}_p = \frac{P_m L A N n}{60}$$

$$37.5 = \frac{800 \times 10^3 \times 1.5d \times \frac{\pi}{4} d^2 \times 2500 \times 4}{60 \times 1000}$$

$$d^3 = 2.3873 \times 10^{-4} \text{ m}^3$$

$$d = 0.062 \text{ m} = 6.2 \text{ cm} \quad L = 1.5 \times 6.2 = 9.3 \text{ cm}$$

$$\eta_{\text{bth}} = \frac{\text{BP}}{m_f \times C_v}$$

$$0.28 = \frac{\text{BP}}{m_f \times 44000}$$

$$\text{bsfc} = \frac{m_f}{\text{BP}} = \frac{1 \times 3600}{0.28 \times 44000} = 0.2922 \text{ kg/kWh}$$

Q. A four-cylinder two-stroke cycle petrol engine develops 30 kW at 2500 rpm. The mean effective pressure of each 800 kN/m² and mechanical efficiency is 80%. Calculate the diameter & stroke of each cylinder if the stroke-to-bore ratio is 1.5. Also calculate the brake specific fuel consumption of the engine, if brake thermal is 28%. The heating value of petrol is 44 MJ/kg.

$$\text{No. of cylinders} = 4, \text{ B.P.} = 30 \text{ kW}$$

$$N = 2500 \text{ RPM}, P_m = 800 \text{ kN/m}^2, \eta_{\text{mech}} = 80$$

$$L/d = 1.5, \eta_{\text{b.th}} = 28\%, C_v = 44 \text{ MJ/kg}$$

$$I_p = \frac{\text{BP}}{\eta_{\text{mech}}} = \frac{30}{0.8} = 37.5 \text{ kW}$$

$$I_p = \frac{P_m L A N n}{60}$$

$$37.5 = \frac{800 \times 10^3 \times 1.5d \times \frac{\pi}{4} d^2 \times 2500 \times 4}{60 \times 1000}$$

$$d^3 = 2.3873 \times 10^{-4} \text{ m}^3$$

$$d = 0.062 \text{ m} = 6.2 \text{ cm} \quad L = 1.5 \times 6.2 = 9.3 \text{ cm}$$

$$\eta_{\text{b.th}} = \frac{\text{BP}}{m_f \times C_v}$$

$$0.28 = \frac{\text{BP}}{m_f \times 44000}$$

$$\text{bsfc} = \frac{m_f}{\text{BP}} = \frac{1 \times 3600}{0.28 \times 44000} = 0.2922 \text{ kg/kWh}$$

Q The mechanical efficiency of single cylinder four stroke engine is 80%. The frictional power is estimated to be 25 kW. Calculate the indicated power (IP) and brake power (BP) developed by the engine.

Solⁿ Data given

$$\eta_m = 80\% = 0.80$$

$$f_p = 25 \text{ kW}$$

$$\eta_m = \frac{BP}{IP}$$

$$IP = BP + f_p$$

$$\Rightarrow f_p = IP - BP$$

$$\Rightarrow 25 = IP - 0.80IP$$

$$\Rightarrow 25 = 0.20IP$$

$$\Rightarrow IP = \frac{25}{0.20} = 125 \text{ kW}$$

$$BP = IP - f_p = 125 - 25 = 100 \text{ kW}$$

Q A 42.5 kW engine has a mechanical efficiency of 85%. and the indicated power and frictional power is assumed to be constant with load, what will be the mechanical efficiency at 60% of the load.

Data given BP = 42.5 kW

$$\eta_{\text{mech}} = 85\% = 0.85$$

$$IP = ?$$

$$f_p = ?$$

$$\eta_{\text{mech}} = \frac{BP}{IP} \Rightarrow IP = \frac{BP}{\eta_{\text{mech}}} = \frac{42.5}{0.85} = 50 \text{ kW}$$

$$f_p = IP - BP = 50 - 42.5 = 7.5 \text{ kW}$$

$$\text{Brake Power at 60\% load} = 42.5 \times 0.6 = 25.5 \text{ kW}$$

$$\eta_{\text{mech}} = \frac{BP}{IP} = \frac{BP}{BP + f_p} = \frac{25.5}{25.5 + 7.5} = 77.3\%$$

8/ Find out the speed at which a four-cylinder engine using natural gas can develop a brake power of 50 kW working under following conditions. Air-gas ratio 9:1 calorific value of the fuel = 34 MJ/m^3 , compression ratio 11:1, volumetric efficiency = 70%, indicated thermal efficiency equal to 35% and the mechanical efficiency = 80% & the total volume of the engine is 2 liters.

Data given, BP = 50 kW

Air/gas = 9:1

CV = 34 MJ/m^3

$r = 10:1$

$\eta_{vol} = 70\%$

$\eta_{mech} = 80\%$

$\eta_{th} = 35\%$

$$\text{Total volume/cylinder } V_{tot} = \frac{2000}{4} = 500 \text{ cc}$$

$$\text{Swept volume/cylinder } V_s = \frac{9}{10} \times 500 = 450 \text{ cc}$$

$$\begin{aligned} \text{Volume of air taken in/cylinder} &= \eta_v \times V_s \\ &= 0.7 \times 450 = 315 \text{ cc} \end{aligned}$$

$$\text{Volume of gas taken in/cy} = \frac{315}{9} = 35 \text{ cc}$$

$$\text{Energy supplied/cylinder, } E = 35 \times 10^{-6} \times 34 \times 10^3$$

$$= 1.19 \text{ kJ} \quad \text{--- (1)}$$

$$\text{indicated thermal efficiency } \eta_{th} = \frac{P_{ip} / \eta_{mech}}{\text{Energy supplied/cylinder/s}}$$

$$\text{Energy supplied/cylinder/s } E_1 = \frac{50 \cdot 0.8}{0.35 \times 4} = 44.64 \text{ kJ}$$

$$\text{Now } \text{energy supplied per cylinder kJ} = \frac{K_1}{N/120}$$

$$= \frac{44.64 \times 120}{N} = \frac{5356.8}{N} \quad \text{--- (2)}$$

$$\frac{5356.8}{N} = 1.19$$

$$\Rightarrow N = 4500 \text{ rpm}$$

Q1 The following particulars refer to a 2-stroke diesel engine
 bore = 10 cm, stroke = 15 cm piston speed = 300 m/min, torque
 developed = 58 Nm, mechanical efficiency = 80%, indicated
 thermal efficiency = 40%, calorific value of fuel = 44 MJ/kg.
 Determine (a) indicated power (b) indicated mean effective
 pressure (c) fuel consumption per kWh on brake power
 out put.

Data given $d = 10 \text{ cm} = 0.1 \text{ m}$
 $L = 15 \text{ cm} = 0.15 \text{ m}$

piston speed = $2LN = 300 \text{ m/min}$, $T = 58 \text{ Nm}$

Type of engine = 2-stroke diesel

$C_v = 44 \text{ MJ/kg}$, $\eta_{\text{mech}} = 0.80$, $\eta_{\text{ith}} = 0.40$

$2LN = 300$; $N = \frac{300}{2 \times 0.15} = 1000 \text{ rpm}$

$\eta_{\text{mech}} = \frac{BP}{IP}$, $BP = \frac{2\pi NT}{60} = \frac{2\pi \times 58 \times 1000}{60 \times 1000} = 6.073 \text{ kW}$

$IP = \frac{6.073}{0.8} = 7.592 \text{ kW}$

$IP = \frac{P_m L A \cdot N}{60} = \frac{P_m \times L \times \frac{\pi}{4} d^2 \cdot N}{60}$

$P_m = P_{\text{mean}} = \frac{60 \times 7.592 \times 4 \times 1000}{0.5 \times \frac{\pi}{4} (0.1)^2 \times 1000 \times 1} = 386666.67 \text{ N/m}^2$
 $= 386.66 \text{ kN/m}^2$

$\eta_{\text{ith}} = \frac{IP}{m_f \times C_v} = \frac{BP}{m_f \times C_v \times \eta_{\text{mech}}} = \frac{6.053 \times 3600}{m_f \times 44000 \times 0.8}$

$m_f = \frac{7.592 \times 3600}{0.4 \times 44000} = 1.5529 \text{ kg/h}$

$\text{bsfc} = 1.5529 / 6.073 = 0.2557 \text{ kg/kWh}$

Q1 Designing a trial of a four-cylinder 4-stroke petrol engine coupled to a hydraulic dynamometer at constant speed the following readings were obtained.

$$\text{B.P with all cylinders operating} = 14.7 \text{ kW}$$

$$\text{B.P with cylinder no 1 cut out} = 10.14 \text{ kW}$$

$$\text{B.P with cylinder no 2 cut out} = 10.3 \text{ kW}$$

$$\text{B.P with cylinder no 3 cut out} = 10.36 \text{ kW}$$

$$\text{B.P with cylinder no 4 cut out} = 10.21 \text{ kW}$$

$$\text{Fuel consumption} = 5.5 \text{ kg/h}$$

$$\text{Calorific value of fuel} = 42 \text{ MJ/kg}$$

$$\text{Diameter of cylinder} = 8 \text{ cm}$$

$$\text{Clearance volume} = 0.1 \text{ lit}$$

Calculate (a) mechanical efficiency, (b) relative efficiency, (c) indicated power basis.

$$IP_1 = 14.7 - 10.14 = 4.56$$

$$IP_2 = 14.7 - 10.3 = 4.4$$

$$IP_3 = 14.7 - 10.36 = 4.34$$

$$IP_4 = 14.7 - 10.21 = 4.49$$

$$\text{Total IP} = 4.56 + 4.4 + 4.34 + 4.49 = 17.79 \text{ kW}$$

$$\eta_{\text{mech}} = \frac{\text{B.P}}{\text{IP}} = \frac{14.7}{17.79} = 0.8263 \approx 82.63\%$$

$$V_s = \frac{\pi}{4} d^2 \times l = \frac{\pi}{4} (0.08)^2 \times 0.1 = 5.0265 \times 10^{-4} \text{ m}^3$$

$$V_c = 0.1 \text{ lit} = 0.1 \times 10^{-3} = 10^{-4} \text{ m}^3$$

$$\text{Compression ratio} = (r) = \frac{V_s + V_c}{V_c} = \frac{5.0265 \times 10^{-4} + 10^{-4}}{10^{-4}} = 6.0265$$

$$\text{Air standard efficiency} = 1 - \frac{1}{(r)^{\gamma-1}} = 1 - \frac{1}{(6.0265)^{1.4-1}} = 0.5215$$

$$\text{Indicated thermal efficiency} = \frac{IP \times 3600}{m_f \times CV} = \frac{17.79 \times 3600}{5.5 \times 42000} = 0.2772$$

$$\text{Relative efficiency} = \frac{0.2772}{0.5215} = 0.5316 \approx 53.16\%$$

Q A gas engine has piston diameter of 150mm, length of stroke 400mm and mean effective pressure 5.5 bar. The engine makes 120 explosions per minute. Determine the mechanical efficiency of the engine if its BHP is 5 kW

Data given

$$d = 150 \text{ mm} = 0.15 \text{ m}$$

$$L = 400 \text{ mm} = 0.4 \text{ m}$$

$$P_m = 5.5 \text{ bar}$$

$$n = 120, \text{ BHP} = 5 \text{ kW}$$

$$A = \frac{\pi}{4} d^2 = 0.0177 \text{ m}^2$$

$$IP = \frac{P_m \cdot L \cdot A \cdot n}{60} = \frac{5.5 \times 100 \times 0.4 \times 0.0177 \times 120}{60} = 7.79 \text{ kW}$$

$$\eta_{\text{mech}} = \frac{\text{BHP}}{IP} = \frac{5}{7.79} = 0.642 \approx 64.2\%$$

$$1 \text{ W} = 1 \text{ J/s} = 1 \text{ Nm/s}$$

$$1 \text{ Pa} = 1 \text{ N/m}^2$$

$$1 \text{ bar} = 10^5 \text{ Pa} = 100 \text{ kPa} = 0.1 \text{ MPa}$$

5 COOLING SYSTEM

5.1 Necessity & types of the Engine cooling

- * Basic purpose of cooling system is to keep the engine at an appropriate operating temperature, no matter under what conditions the vehicle is running.
- * In other words the cooling system is provided to dissipate the heat developed due to the engine operation and the combustion process.
- * And to cool the engine to a suitable temperature so that any parts of the engine is prevented from over heating.
- * The temp^r as high as 2500°C is generated inside the engine during combustion.
- * All of the heat produced by the combustion of air-fuel mixture in the engine cylinder is not converted into useful mechanical work (or power) at the crank shaft.

Distribution of fuel energy

- (a) useful mechanical work at the crank shaft - 25%
- (b) Loss to the atmosphere by exhaust gases - 35%
- (c) Loss in friction (passes on to the lubrication system) - 5%
- (d) Loss to the cylinder walls - 30%

- # The over heating of engine can cause pre-ignition of the charge, detonation and knocking.
- # This will reduce the volumetric efficiency and power developed in the engine, thus considerably reducing the life of engine.

→ It keeps the engine at its most efficient operating temp^o at all speeds and operating condition.

→ It also helps in bringing the engine up to normal operating temp^o as quickly as possible.

TYPES OF COOLING SYSTEM

There are two types cooling systems used in case of IC engine

- (1) Direct cooling or air cooling
- (2) Indirect cooling or water cooling system

5.2 Air cooling / Direct cooling

In case of the air cooling system or the direct cooling system air is brought in contact with the engine parts. How ever the specific heat of air is low (2.4), in this system heat is directly transferred to the air and hence it's called as direct cooling system. This type of cooling system is mostly employed in light engines such as motor cycles & scooters. The heat dissipated in air cooling depends upon the following factors

- (a) Surface area of metal in contact with air
- (b) Mass flow rate of air
- (c) Temp^o difference betⁿ the heated surface & air
- (d) And conductivity of metal

Thus for effective cooling, the air cooled engines contain fins or ribs on the outer surface of the cylinder and cylinder heads. These fins provide more surface area for air contact resulting in better radiation of heat. For better air cooling the cooling surface area of cylinder is increased by increasing number of fins.

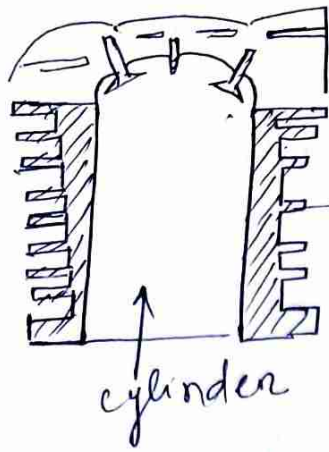

cylinder
cast with
fins.

WATER COOLING

In water cooling system water is used as cooling medium. The water jacket are provided around the each cylinder, cylinder head, combustion space and the valve openings. The water circulates through these jackets and takes away the heat. The heat flows from the cylinder wall into the water which goes to the radiator, where it is cooled by air through an array of cooling fins. Then the coolant is recirculated to the engine. These are two types

- (i) Thermosyphon system
- (ii) Pump circulation system

Thermosyphon System

This system is very simple, which was used in earlier in automobiles and now obsolete. This system works on principle, that hot water being lighter rises up and cold water being heavier remains at bottom (or falls down). Thus this system depends upon gravity to circulate the water in the system.

In this system, there is no pump to circulate the water in the system. The radiator is connected to the engine through flexible hoses.

- The radiator header tank is kept above the level of water jackets.
- When the water in water jackets becomes hot due to the engine combustion it expands & becomes lighter.
- The hot water rises up and cold water takes its place.
- The hot water then flows to the radiator from the top side.
- It is cooled there by the air passing through the radiator core.
- The cold water being heavier, moves downwards to take the place of displaced ^{hot} water.
- In this way, a circulation is set up in the system, due to which the heat is carried away from engine.

Advantages

- (i) It is simple in construction.
- (ii) It is quite cheap to make.

Dis Advantages

- (i) It has slow cooling rate.
- (ii) The quantity of water required large.
- (iii) It has bulky due to required high water level.

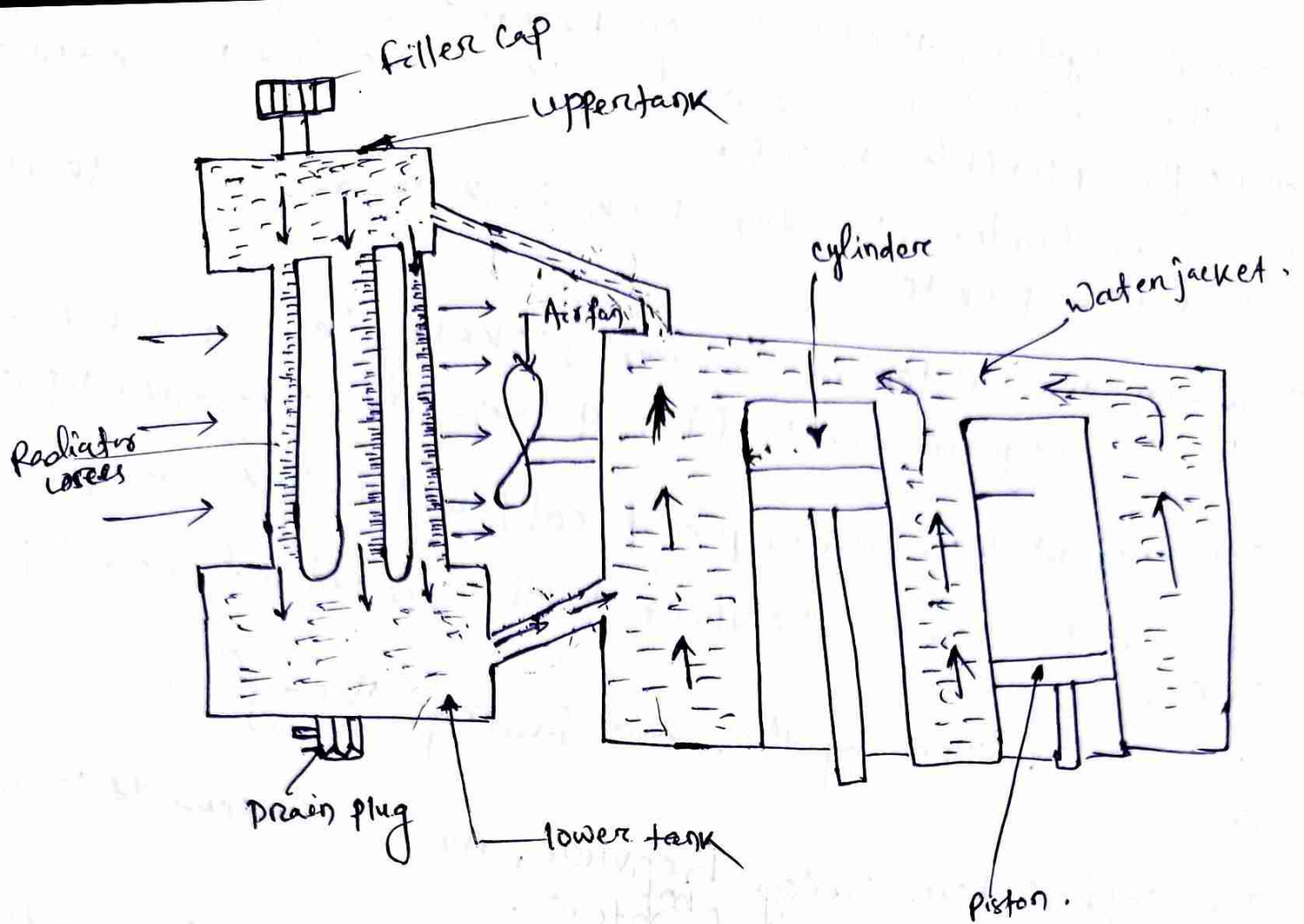

PUMP CIRCULATION SYSTEM

- The pump circulation system is now commonly used in automobiles and similar to the construction of thermo-syphon system.
- The only difference is that in this system a centrifugal pump is used for circulation of coolant.
- The pump is driven by the a v-belt from a pulley on the engine crank shaft.
- Also a thermostat is fitted betⁿ the engine and the radiator which is used to control the flow of coolant.
- when the engine starts from cold the thermostat closes to prevent coolant from entering the radiator until the engine has warmed.

* It has been observed that the coolant only circulates around the engine when the thermostat is closed.

→ With out closure of the thermostat, the engine takes excessively long time to reach its optimum working temp.

→ When the engine warmed up and the coolant temp^s is increased to certain value, then thermostat opens and the coolant is circulated through the water jacket.

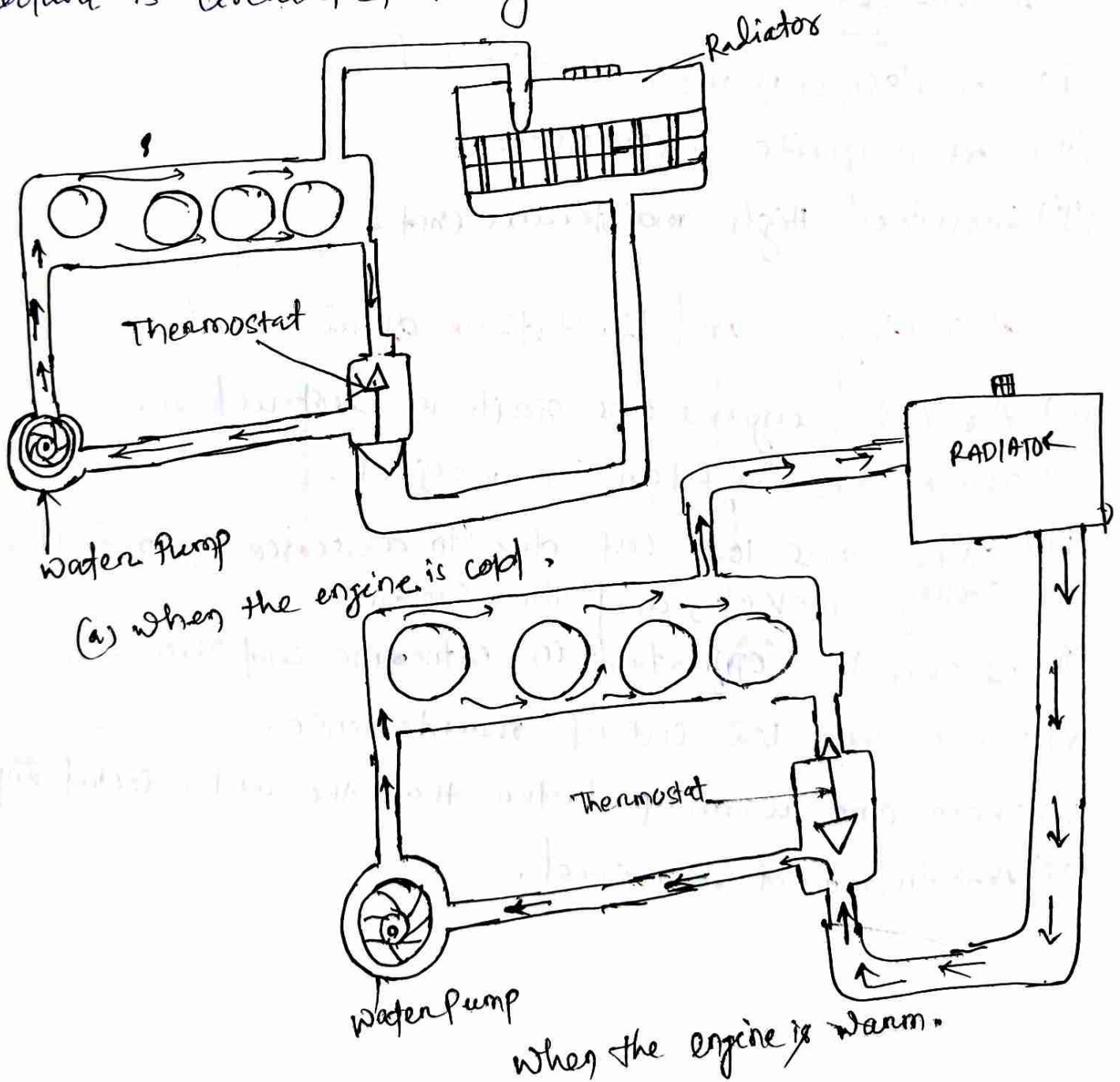

Advantages

- (i) Rate of cooling is fast due to circulation of coolant is quite fast.
- (ii) It does not require large quantities of coolant.
- (iii) The circulation of water to additional area requiring cooling is possible.
- (iv) The radiator can be placed in front side or rear side.

DisAdvantages

- (i) The design is more complicated.
- (ii) It is quite expensive.
- (iii) Required high maintenance cost.

5.3 Advantages and limitations of air cooling.

- (i) Air cooled engines are simple in construction.
- (ii) These are lighter in weight.
- (iii) These are low cost due to absence of radiator, cooling jacket, and the coolant.
- (iv) It can be operated in extreme cold climate.
- (v) These are low cost of maintenance.
- (vi) These are warm up faster than the water cooled engines.
- (vii) Anti freeze not required.

Disadvantages or Limitations:-

- (i) The air cooled engines can't provide uniform.
- (ii) Only used in light engines as single cylinder engine
- (iii) It has higher noise level.
- (iv) Air cooling systems gives low power output.
- (v) These are subjected to high working temp.

5.4 Water pump, thermostat, radiator

WATER PUMP

- The water pump forces the coolant to circulate around the cooling system.
- It is fitted at the front end of the cylinder block, bet the block and radiator.
- It is driven ~~the~~ by the engine crank shaft via the timing belt.
- Water pump is generally centrifugal type pump.
- When the engine is running, the belt drive turns the pulley which drives the shaft in the middle of the pump.
- That shaft is connected to the impeller and as impeller spins, it draws coolant into its centre.
- Then the centrifugal force is generated by the impeller pressurize the coolant.
- And forces it out through the pump outlet, into the engine cooling circuit.
- The pump inlet is connected to the lower tank of the radiator through hose.
- The coolant from the radiator is drawn into the pump to replace the coolant forced out through the inlet.

THERMOSTAT

The main purpose of the thermostat is to prevent overcooling of the engine. The thermostat is placed on the radiator's outlet side passage. When the engine is started from cold, it does not require cooling. If the cooling system operates at the start of the engine, the correct operating conditions will not be achieved in fast manner and engine will take appreciable time to reach to the operating condition. Thus for this reason, a thermostat is provided in a cooling system. The thermostat closes to ensure that the engine reaches its operating quickly. When closed, the thermostat prevents coolant from entering the radiator and being cooled but the coolant circulates inside the engine through a by-pass port. When the coolant temp^s exceeds a preset level, the thermostat allows into the radiator for cooling.

RADIATOR

- A radiator very efficiently lowers the temp^s of the coolant passing through it.
- It consists of mainly three parts - an upper tank, lower tank, ~~radiator~~ and heat radiating core.
- The upper tank and lower tank are joined by the radiator core.
- The upper tank contains a neck through which coolant enters to the radiator.
- An overflow pipe is connected to the side.
- The upper tanks and lower tanks are usually made from plastic to make radiator lighter.
- The core is made from copper or brass.
- Now a days, aluminium is also used from weight and consideration. And these parts are assembled in one part & can't be separated.

- The lower tank contains connection of for the outflow of coolant.
- A drain lock is provided at the bottom of lower tank to remove coolant from the radiator during repairs or replacement of coolant.

These are basically

- ① According to construction of core
 - (a) tubular
 - (b) ~~honey~~ honey comb or cellular
- (2) According to direction of coolant flow
 - (a) Down flow radiator
 - (b) Cross flow radiator

5.5 Anti Freezing & Anti Corrosive

Coolant (Anti-freeze solution)

In water cooling engines, water is universally used to absorb and transfer heat from the engine, for preventing over-heating. Water is a good to use for absorbing and transferring heat, but it has few drawbacks.

- (i) It easily freezes
- (ii) relatively low boiling point
- (iii) It causes rust
- (iv) scale formation on the part.

Due to the above reason, anti freeze solutions are mixed with water to prevent above causes.

- (i) It should mix easily with water
- (ii) It should be non corrosive
- (iii) It should be high boiling point.

- (iv) It should not damage the cooling system.
- (v) It should prevent the freezing of mixture.
- (vi) It should not lose its ~~freezing~~ anti-freeze solution.

Common Anti-freeze solutions are

- (a) Ethylene glycol
- (b) Methanol alcohol or Methanol
- (c) Distilled glycerine

Ethylene glycol ($C_2H_6O_2$) best anti-freeze material.

~~The~~ The mixture of water and ethylene glycol is known as coolant.

6 LUBRICATION SYSTEM

6.1 Types, requirements and Properties (Flash Point & Fire Point) of ~~Lubrication~~ Lubricants

Lubrication system supplies oil to the frictional parts of the engine, rotating and sliding components. An oil film is formed to prevent metal parts from coming into direct contact with one another. The oil film betⁿ the parts allows them to move easily, with less friction.

Types of Lubrication system

The different types of lubrication systems are used in the Auto engine, for lubricating the parts. These are

- (i) Petrol or Mist system
- (ii) splash system
- (iii) Pressure feed or wet sump system
- (iv) Dry sump system
- (v) semi-pressure type

Requirements

- (i) It reduces the friction betⁿ moving parts of the engine, by preventing metal to metal contact.
- (ii) Reduces the wear of the engine parts.
- (iii) Seal the internal parts of the engine, it produces an effective seal betⁿ piston rings and cylinder wall. for preventing leakage.
- (iv) Cool the engine, because thin layer is produces in betⁿ the the moving parts, that's layer absorbs some heat produce in the engine.
- (v) Clean the inside engine, the circulating lubricating oil carries away the carbon & other contamination to the oil Pan

(vi) Provides cushioning effect, by absorbing the shocks produced by sudden loading imposed on the engine components.

(vii) It also reduces the noise and increases the engine life.

(viii) Prevents corrosion, protection against the corrosion to various parts on the engine by preventing metal to air contact.

Properties :-

Flash Point :- The flash point of an oil is defined as the lowest temp^s at which it gives sufficient vapour to produce a momentary flash, when a test flame is brought near its surface. Flash point should be higher.

Fire Point :- The fire point of an oil is the temp^s at which it ~~becomes~~ burns continuously, when a test flame is brought over its surface. generally up to 8°C higher than flash point.

Cloud Point :- when an oil is cooled slowly, the temp^s at which it becomes cloudy or hazy in appearance is called cloud point.

6.2 Types of lubrication system gravity type, splash type, Pressure type, dry sump type, semi-Pressure type etc.

The different types of lubricating systems are used for lubrication of different components of engine

- (1) Petrol or mist system
- (2) splash system
- (3) Pressure feed or wet sump system
- (4) combined splash and pressure feed system
- (5) Dry sump system

Petrol or Mist system

- (i) This type of lubrication system is generally used in light weight two stroke engines. like scooter and motor cycle.
- (ii) It is very simple and does not require any oil pump or filter.
- (iii) This type system also known as mist lubrication system.
- (iv) In this system 2% to 3% of lubricating oil is mixed with the petrol.
- (v) For that reason it is called petrol system.
- (vi) The percentage of oil is depends on grade of lubricating oil.
- (vii) When the engine runs the petrol mixture (vapour form) enters to the engine cylinder. The oil particles which are mixed with the petrol, lubricate the piston, piston rings, cylinder walls, connecting rod & other elements.

Splash system:-

In ~~the~~ ^{splash} this system of lubrication, a splash of the lubricating oil is produced for lubricating the various parts.

(ii) This system suitable for both single cylinder and multi cylinder engines.

(iii) It is the cheapest method of lubrication.

(iv) It is very simple in construction.

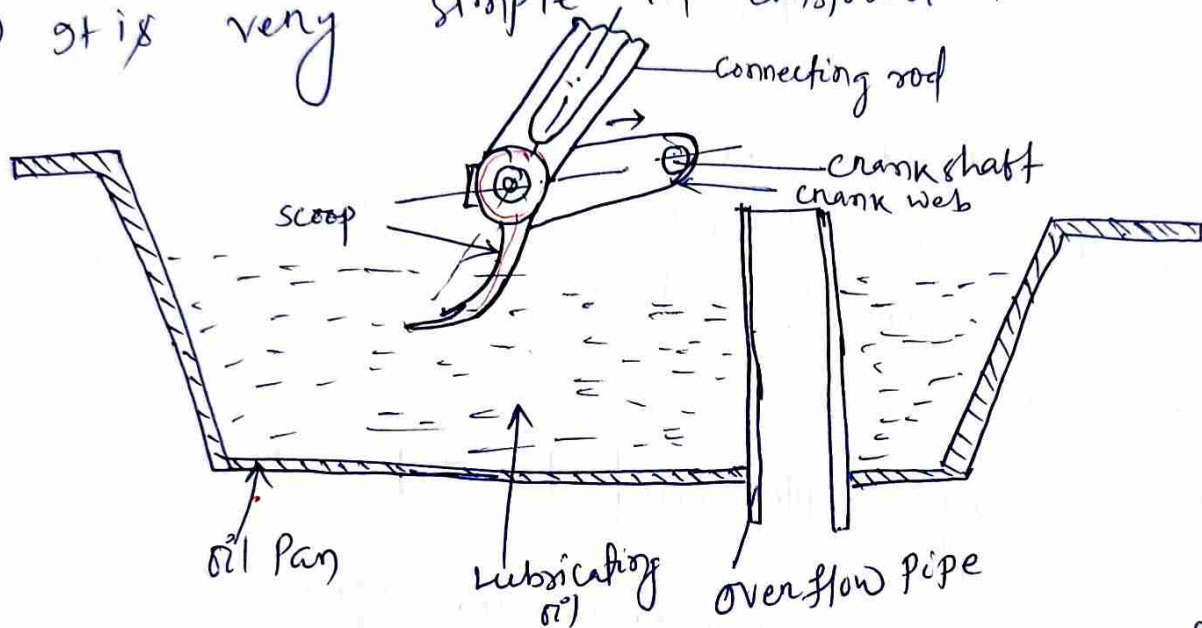

(v) In this system, the lubricating oil is contained in the oil pan as sump.

(vi) A scoop or dipper made of pressed steel is attached to the lower side of big end of connecting rod.

(vii) When engine operates the dipper dips in the oil and causes the oil to splash on the cylinder wall.

(viii) Thus this action affects the lubrication of the engine wall, crank pin, crank shaft bearings etc.

Pressure feed or Wet sump System

- (i) The Pressure feed system is employed universally in all modern engines.
- (ii) In this system the oil pump is used.
- (iii) which is directly driven by the crank shaft.
- (iv) Pump sucks the oil from sump or oil pan through the strainer, which removes large impurities.

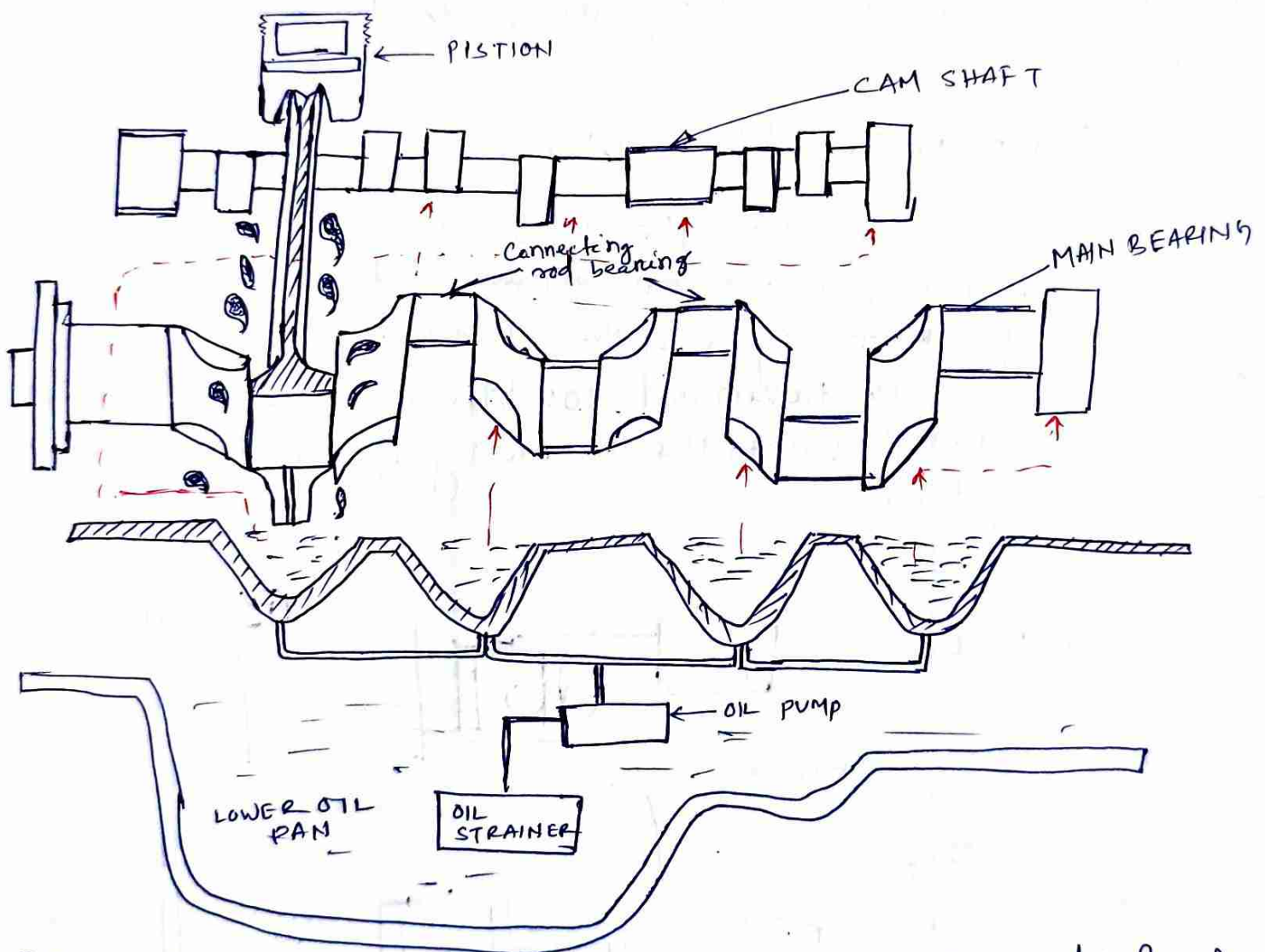

- (v) The pressurized oil then passes through a relief valve which is fitted at the out let of the pump.
- (vi) The pump's pressure relief valve regulates the oil pressure.
- (vii) From the relief valve, the oil passes through the oil filter which removes the smaller impurities.

(viii) On some high pressure performance engines an oil cooler is provided before the filter.

(ix) The filtered oil is then fed to the cylinder block and cylinder head.

(x) After passing through various passage in the cylinder block cylinder head and other area, then lubricates all of the moving parts of the engine.

(xi) Finally after lubricating all parts the oil returns to the oil pan.

Dry Sump Lubrication System.

A system in which the lubricating oil is stored in the oil pan is called wet sump system. But the system in which the sump kept dry and the oil collected in the sump after lubrication is taken out for filtering and cooling and then again pumped onto the bearing is called dry sump lubrication system.

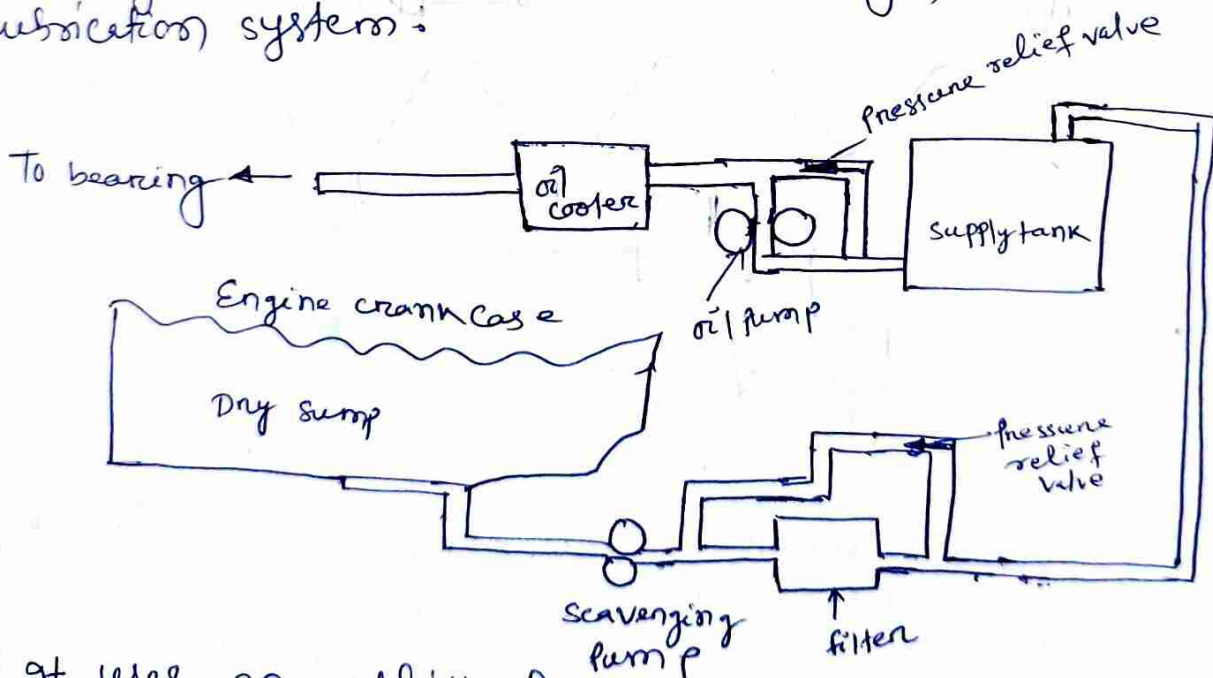

* It uses an additional pump as well as remote oil tank

* It is used in situations when a wet sump can't cope with supply the oil, in unusual or extreme condition, heavy acceleration (racing car), off road driving, steep hills & uneven surface.

- In dry sump lubricating system, the supply of oil is carried in an external tank.
- An oil pump draws oil from the supply tank and circulates it under pressure to the various bearings of the engine.
- Oil dripping from the cylinders and bearings into the sump is removed by a scavenging pump, which is turns the oil passed through a filter, is fed back to the supply tank.
- This system ensures that in these cases (unusual or extreme condition) there is no make down of oil supply.

6.3 Parts of Lubricating system like oil sump, oil cooler, oil filter, oil pressure gauge, oil pressure indicating light, oil table indicators.

Oil sump or oil Pan

The oil pan or sometimes commonly called as oil sump, from the bottom section of engine. It provides a covering for the crankshaft and other parts contained in a crank chamber. In wet sump lubrication system oil is contained in a sump and thus it is known as oil sump or oil Pan. This Pan is made up of steel or aluminium. It is designed to hold sufficient quantity of oil for the lubrication of the engine.

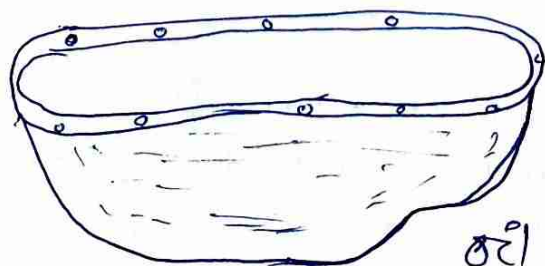

oil sump.

Oil strainer or oil filter

The oil coming back to the oil Pan is strained through the strainer before it is fed to the engine. The strainer is a screen that prevents the foreign particles from entering the oil pump. Mostly it is located in the oil Pan and hinged to the pump inlet so that any oil entering the pump must pass through it.

Oil Pump

The function of oil pump is to circulate the lubricant under pressure to lubricate most of the working parts. The pump is located either inside the crank case or below the oil level in the sump. It is generally driven by a gear mounted on the camshaft. The following types of pumps are used in lubrication system.

- (1) Gear type
- (2) Rotor type
- (3) Plunger type
- (4) Vane type
- (5) Crescent type gear pump.

Oil dipstick

The oil dipstick is used to check the level of engine oil Pan. A hole is provided on the side of the oil Pan of an engine for this purpose. The oil dipstick is a long stick with a handle at one end for holding it on upper side. The lower end of the dipstick is provided with marks indicating full, half full or empty.



Upper mark (Full)
Middle mark (Half)
Lower mark (Empty)

Oil Pressure Indicating Light

The vehicles are generally provided with a warning at the instrument panel which indicates the fall in oil pressure in the system. This red light that comes on only if the pressure drops below a predetermined level.

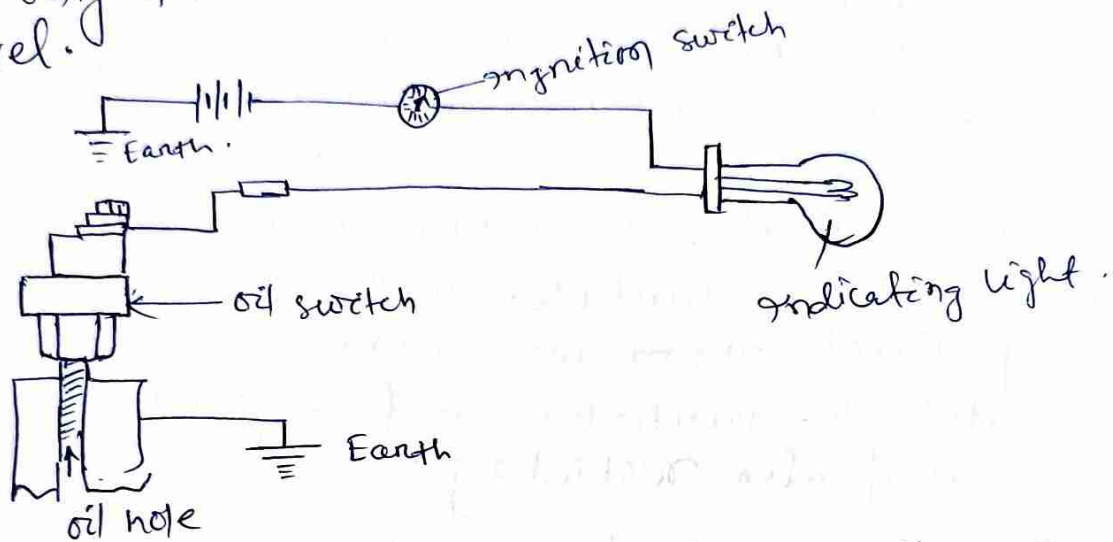

In this system, a pressure sensitive oil switch is connected in series with the ignition switch, indicating bulb and the battery.

Crank Case Ventilation

~~Though~~ Though the piston rings are designed to form a gas tight seal betⁿ the piston and the cylinder walls yet the products of combustion leak from the combustion chamber into crank case. The gasoline vapour and steam are harmful if they are allowed to remain in the engine oil. The steam will be condense and mix with the oil to form a sludge while gasoline vapour will condense & dilute the oil. For removing this ~~process~~ vapour particle from the crank case that process known as crank case ventilation.

6.4 Oil Filters and type - Full flow filter and by pass filter, Crankcase ventilation.

The oil ~~filter~~ after passing through the oil pump and relief valve goes to the oil filter. The oil filter removes ~~oil filter~~ metal particles and sludge from the engine oil. During the engine operation removed due to wear and tear, dirt and other harmful particles are washed away into the sump. If oil is not made free from these harmful particles, engine life will decrease as these particles will come on the way of moving parts. ~~There are~~ Therefore oil filter is used to catch the particles and make the oil free from them and also restricting their free movements.

There are two types of oil filter commonly used in the I.C Engines.

- (i) Full flow oil filter system
- (ii) Branch flow oil filter system

Full flow oil filter system

* In this system, all the oil supplied from the oil pan passes through the oil filter. The filtered oil passes through the oil gallery from where it is supplied to the main bearings and other parts of the engine.

* After long use of the vehicle, the oil filter may become clogged with materials filtered from the oil. This may stop the lubrication of oil to reach the engine parts, as no oil passes easily through the filter element.

* In order to avoid such problems, a bypass is provided in this type of filter.

- * A pressure spring type non-return valve is placed in this by pass, which opens when high pressure is developed due to clogging of filter element.
- * The oil then goes around the filter element instead of through it and directly into the engine.
- * This type of filtration system is commonly used in vehicles.

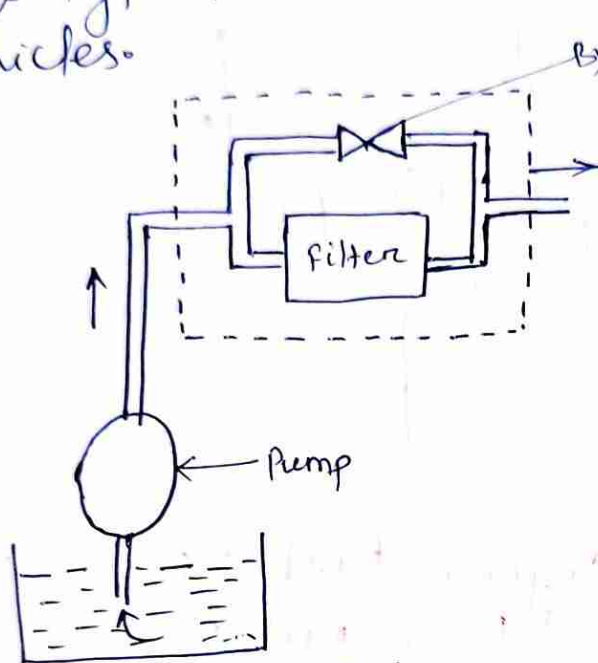

Full flow oil filter system

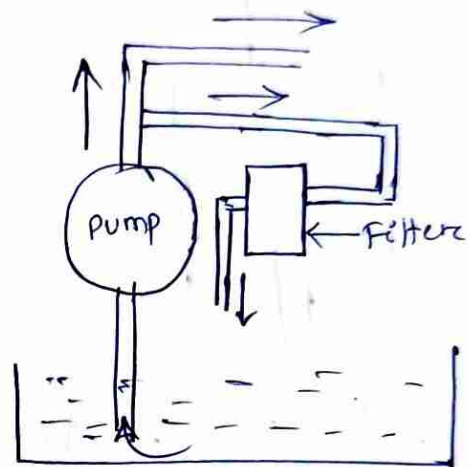

Branch flow oil filter system.

Branch flow oil filter system (Partial lubrication)

- * In this system oil from the oil pump is supplied directly to the Lubricating Parts. (i.e. oil pumped to oil galleries to flow directly to the bearings).
- * But some of it passes through the filter and return to the oil pan.
- * However, in some vehicles the filtered oil does not return directly to the oil pan but is supplied to lubricate the crank shaft and cam shaft.
- * Advantages of this system if filter clogged, the supply of oil to the bearings continues.
- * This type of system now obsolete because it is impossible to clean complete oil, in this method.

4 Fuel Feed system of Petrol & Diesel Engine

4.1 Line Diagram of Petrol engine fuel supply system

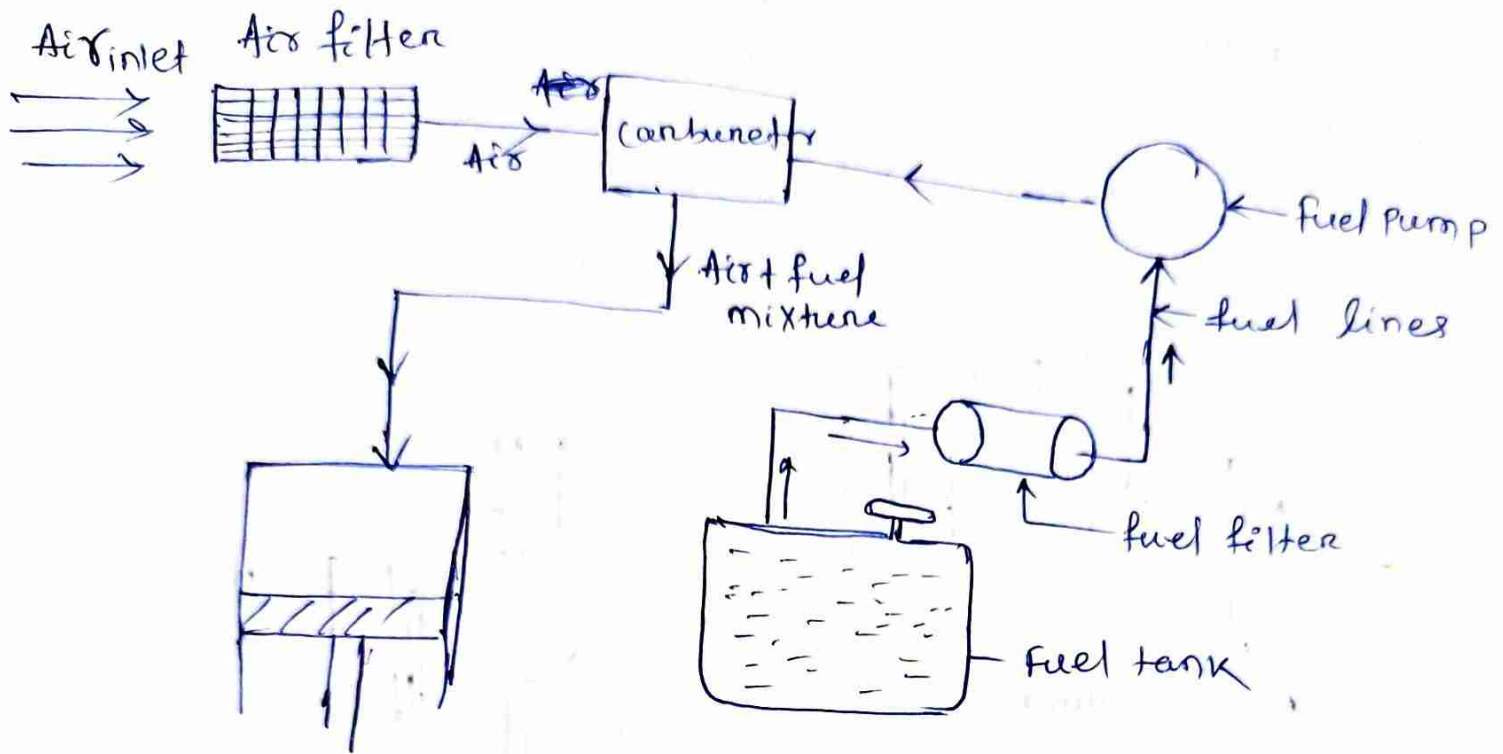

4.2 Components of Petrol engine fuel supply system like fuel tank, fuel lines, fuel pump (mechanical & electrical), fuel filter.

Fuel tank :- The fuel tank is stored the fuel, normally mounted on the vehicle frame. The fuel tank is generally located under the vehicle rear seat (Commercial vehicle) in case of bike fuel tank is fitted on the top & under the handle bar is in front of the driver. Fuel tank is placed centrally also. The fuel tank is fastened with the help of steel straps to secure the tank to the frame. The rubber cushions are provided on the fuel tank so that it does not touch the body directly.

* It is made of steel sheet coated with either (i.e. tin-lead coating) or zinc-nickel. The steel fuel tank is painted on exterior to prevent rust-induced corrosion.

Fuel lines :- The components of the fuel system are connected by fuel and vapour lines and hoses. These are allowing supply of fuel to the carburettor, to return excess fuel to the tank and to carry fuel vapour. Fuel lines must be routed so as to remain cool as possible. There are two types (i) flexible pipe (ii) rigid pipe. The flexible pipes are generally used from fuel tank to the carburettor and the rigid pipe or steel pipes are connected in betⁿ the carburettor to the engine.

Fuel Pump :- It is an essential component of any internal combustion engine. It serves as the mechanical heart of a vehicle and maintains a steady flow of fuel from tank to its engine. Generally ~~the~~ fuel tank is lower than the carburettor, so that petrol (gasoline) does not flow to the carburettor on its own. Some device is required for sending the petrol from tank. That's why need a fuel pump for supply steady flow to the engine.

These are basically two types (i) Mechanical type
(ii) Electrical type.

Mechanical fuel pump - The mechanical pump is generally a diaphragm pump, which is a type of positive displacement pump. It is installed on the cylinder head through a thick bakelite insulator to prevent heat transmission from the cylinder head. Pump is driven by an electric on the cam shaft. The rocker arm of the pump nests against the cam shaft eccentric. As the cam shaft rotates, the eccentric cam causes the pump rocker arm to rise & fall. Some engines use a pushrod betⁿ the rocker arm and cam shaft eccentric. The rocker arm spring holds the arm against

the cam eccentric at all time.

Electric fuel pump :- The advantage of electric fuel pump is that it can be installed at any desirable position. This means that the pump can be mounted away from the engine to reduce the chance of vapour lock. Usually it is mounted close or inside the fuel tank. The mounting of fuel pump inside the fuel tank saves space and simplify the fuel line. It may be noted that the electric pump need not wait for the engine start or it starts operating immediately as the ignition is switched on.

Fuel filter :- The fuel system have at least one filter located somewhere betⁿ the fuel tank and the fuel metering component (i.e carburettor). The fuel filter on the carburetted engines is usually located at the inlet of carburettor or an in-line filter is used betⁿ the fuel pump and carburettor.

Fuel filters are provided to remove the impurities or foreign material from the petrol. The petrol reaching the carburettor must be clean to prevent the clogging of the carburettor jets and passages.

A plated material (generally paper) serves as filter. The fuel enters the housing and flows downward and through the filter, trapping debris betⁿ the filter & the housing.

4.3 Requirements & Working Principle of Carburettors

Air fuel ratio for different conditions in carburettors.

Requirements

- (i) Easy starting of engine at any temp^o.
- (ii) Smooth operation of engine at variable loads & speeds.
- (iii) Good accelerating capabilities.
- (iv) Maximum power at full load.
- (v) Best fuel economy.

Working Principle

The function of the carburettor is to atomise and vapourise the liquid fuel (Petrol) and mixing it with air in correct proportions to meet engine requirements over a wide range of speed and load. The carburettor is mounted on the intake manifold. Opening of the carburettor throttle plate (valve) causes air to move from the higher pressure area outside the engine, through the carburettor, to lower pressure area of manifold. The quantity and speed of travel of air is determined by opening of the throttle plate.

Carburettor air flow must be matched to the air flow requirements of the engine. A carburettor, which provides more air than it is called lean mixture. which provides less air than it is called rich mixture.

Air fuel ratio for different conditions in carburettors

The air-fuel (A/F) ratio is the ratio at which petrol (gasoline) and air are mixed. In general, this is expressed in terms of weight. The air-fuel ratio is necessary to maintain proper combustion and it varies with engine speed, load, temperature and engine design.

Driving condition	Mixture
Starting	Very rich, about 1 to 5:1
No load	Rich about 10 to 12:1
Low speed driving	Relatively rich about 12 to 14:1
Light load driving	Ideal about 15, to 17:1
Heavy load driving	Relatively rich about 12 to 13:1

Function of a carburettor

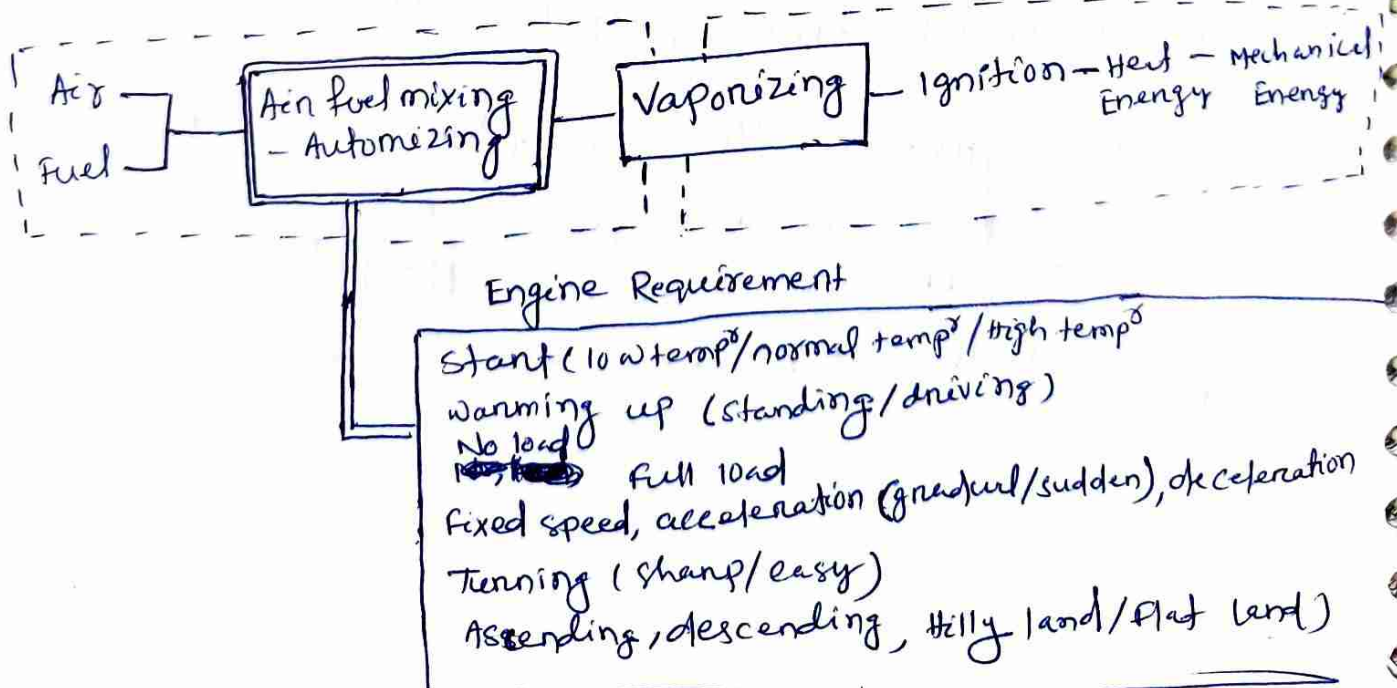

4.4 Circuits of various types of carburettor, like down draught carburettor, side draught carburettor

A vehicle is driven in different conditions. A carburettor must supply suitable air-fuel mixture during all conditions of driving. In order to provide these different mixtures, a carburettor is provided with different circuits for its proper operation. The following are main circuits provide in most carburettors

- (1) float circuit
- (2) idle circuit
- (3) low speed circuit
- (4) main circuit
- (5) high speed circuit
- (6) Acceleration circuit
- (7) choke circuit

Float circuit

It is a part of the basic carburettor. The main purpose of the float circuit is to maintain the level of fuel in float chamber. It functions to ensure a fixed distance is maintained bet^{ween} the fuel level and the top of the nozzle. If the nozzle level is more, too much fuel will reach the jets resulting overflow. The overflow leads to excessive fuel consumption and higher emissions, thus decreasing overall efficiency.

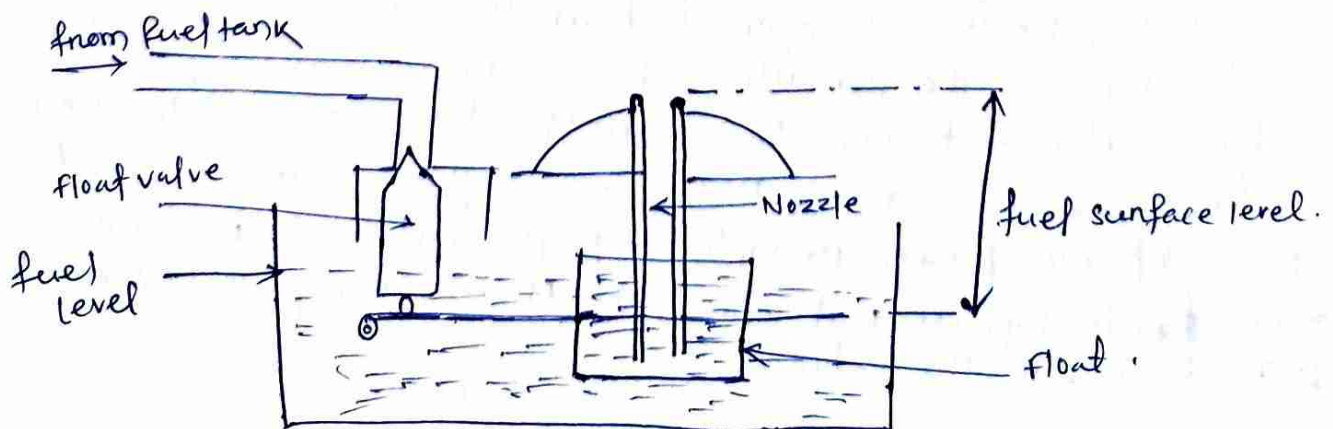

Idle Circuit

When the engine is idling, the throttle valve is almost completely closed (as the accelerator pedal is not depressed at all). In this case there is very little air flowing through the venturi and there is no Venturi effect to draw fuel from the main fuel nozzle. Thus main circuit can't be used to supply the air-fuel mixture just below the throttle valve.

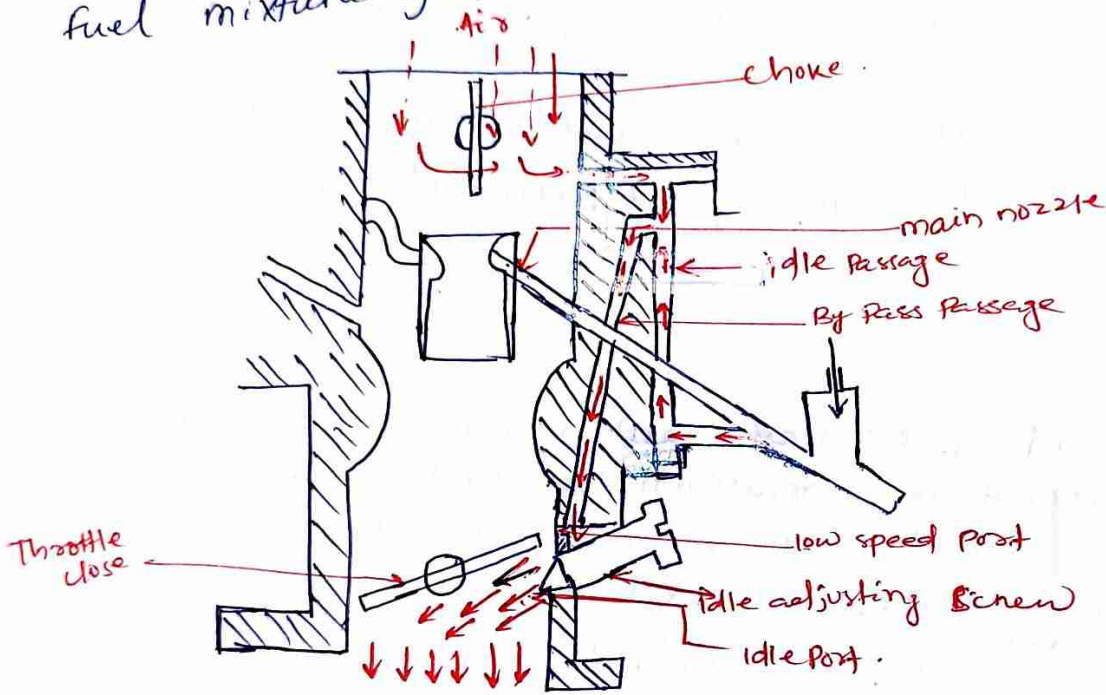

Low speed circuit

When the vehicle is operated at low speed slightly past the idle position, the throttle valve is opened slightly. But there is still insufficient air flow through the venturi to draw the fuel from the main nozzle. It may be required more fuel that can be provided by the idle port alone. Another small by pass port known as slow running port is provided just above the throttle valve.

Main circuit

The main circuit supplies air-fuel mixture during normal driving to achieve best fuel economy. As the throttle valve opens, it allows enough air to flow through the air horn to build ~~some~~ sufficient vacuum in the venturi, and fuel is supplied from the main nozzle in the venturi.

High speed

On high speed operation i.e. when engine rpm are increased to high speed levels, the fuel ~~required~~ requirements are high. In this case, the throttle valve is fully opened and the air flowing through carburettors creates a strong vacuum at the venturi. Thus in this case higher rate of fuel requirements are fulfilled by metering rod.

Acceleration circuit

The acceleration circuit provides rich mixture (i.e. extra fuel) for acceleration when the driver wants to accelerate quickly to overtake another vehicle. When the accelerator pedal is pressed down suddenly, the amount of air flow increases immediately, but since the fuel has higher specific gravity (i.e. it is slower), therefore a brief interval is required before the fuel gains speed and maintains the desired balance of fuel and air. Therefore, the air-fuel ratio becomes temporarily lean at a time when a rich mixture is actually required for more power.

Choke circuit

The last major circuit of the carburettor is the choke circuit. When the engine is cold, a rich mixture is required to start it. The choke circuit consists of a choke valve, placed in the air horn of the carburettor above the venturi. The choke valve is simply butterfly valve. It is operated either mechanically or automatically.

Types of carburettor

Basically these are three types

- ① Down draft / down draught
- ② up draft / up draught
- ③ Side draft / side draught

① Down draft: This type of carburettor is most commonly used. In this type the air-fuel mixture flows downward towards the intake manifold. It is fitted above the intake manifold and use the effect of gravity on the air-fuel flow, which helps to prevent any lag in the fuel flow.

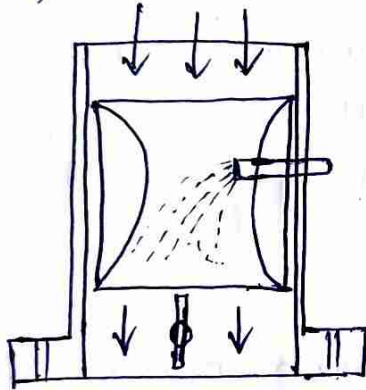

② up draft: - In this type of carburettor, the air-fuel mixture flows upward towards in the intake manifold. It is placed in ~~top~~ below the intake manifold. These are very popular many years ago, but no longer used on new cars.

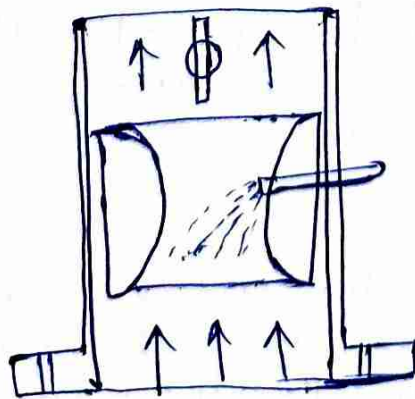

③ Side draft :- In this type carburettor, the air-fuel mixture flows horizontally towards the intake manifold. It is used primarily in compact car and on motor cycles. The air-fuel mixture flows sideways, therefore the air flow resistance is low and intake efficiency is improved. And also overall height can be reduced.

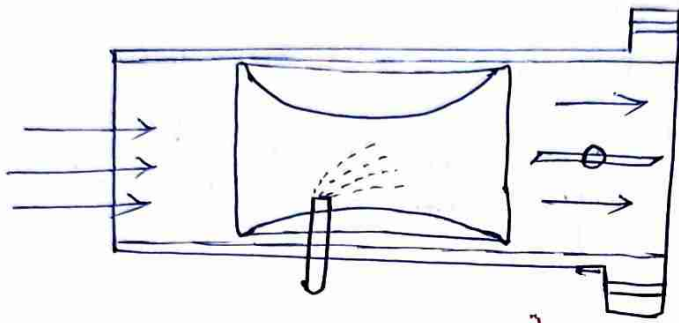

4.6 line diagram of diesel fuel supply system

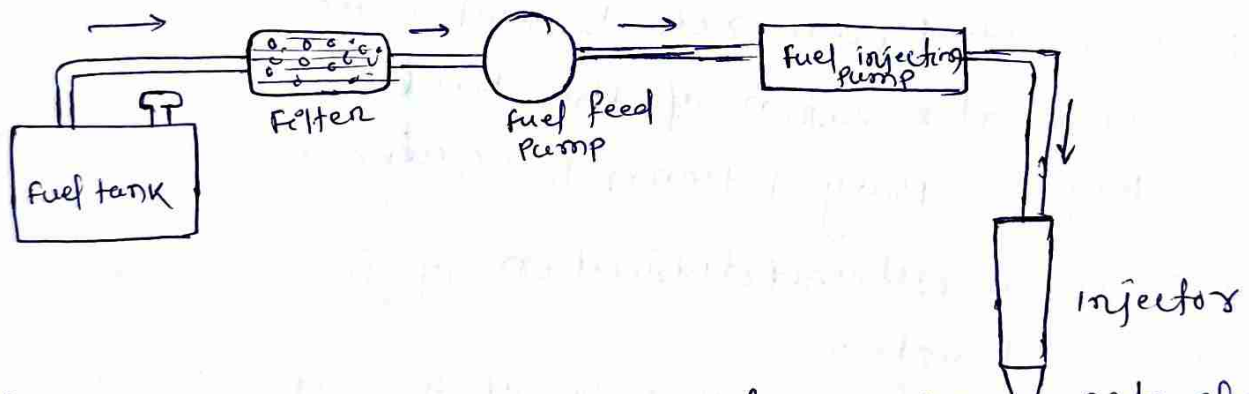

Fuel tank :- The fuel tank is placed along the side of the vehicle chassis and stores the fuel.

Filter :- In diesel engine, generally two types filter are used to remove water and dirt particle from the diesel. Primary filter is generally fine coarse wire gauze. It prevent large solid particle and water from going to the fuel feed pump.

Feed Pump :- The fuel feed pump is used to deliver fuel from the fuel tank to the fuel injection pump. The rate of fuel delivery depends upon the engine requirement.

Fuel injection Pump: - The fuel injection pump is used to supply the exact amount of metered fuel under high pressure, in proper sequence and at the correct timing according to requirement of engine.

Fuel injector: The fuel injector is used to inject the fuel in proper atomized form under high pressure, for proper burning of fuel in the engine cylinders.

Governor: - is used to control the engine speed. also regulates the fuel supply under all condition.

4.7 Requirements and types of fuel injection system

Requirements: -

- (i) Accurate metering of the fuel injected per cycle
- (ii) Correct fuel injection timing
- (iii) Full control over rate of fuel injection
- (iv) Proper atomization of the fuel
- (v) Proper spray pattern to ensure mixing of air & fuel
- (vi) uniform ~~dist~~ distribution of fuel in the combustion chamber
- (vii) To supply equal quantity of the fuel in all the cylinders (in multi cylinder engine)
- (viii) No lag betⁿ beginning and end of injection process.

Types of injection system

- (i) Air blast injection system
- (ii) Airless or solid injection system
 - (a) Common rail fuel injection system
 - (b) Individual pump injection system
 - (c) Unit injection system
 - (d) Distributor injection system

4.8 Air injection, solid injection, individual pump system injection, common rail system injection

Air Blast injection: - in this type of all the systems, air is compressed to a very high pressure by means of multi-stage compressors and this blast of air is used to inject the fuel into the cylinder. Thus it can be said that high pressure air flows into the engine cylinder carrying along with it the metered fuel as a finely atomized spray. The air compressor is driven by the engine ~~crank~~ crankshaft. This method was previously used in large, stationary and marine engines, but in present day it has become obsolete.

The rate of fuel supply to the engine controlled very effectively by varying the pressure of the air. The high pressure air requires a multi-stage compressor to keep the air bottles charged. The fuel is ignited by the high temp^o of the air caused by high compression. The compressor consumed 10 to 14% of the power developed by the engine. Thus, the output of the engine is decreased. This system is also quite complicated and expensive.

Airless or solid injection system

This system has mostly replaced the air blast injection method and is used in all types of small and big diesel engine. In this system, only the ~~air~~ liquid fuel under high pressure is directly injected into the combustion chamber of the engine cylinder. The fuel is burnt due to the heat of compression of the air. This system requires a fuel pump to supply the fuel at high pressure.

* This system simple in construction

* Light. in weight

* It is not so expensive

These are 4 types.

Common Rail fuel injection system

The common rail fuel injection system, comprises of a high pressure, constant stroke and constant delivery pump, which supplies fuel at high pressure to a common rail, to which each fuel injector is connected. In this system rail is used which is maintain high pressure common rail for all cylinders, and hence the name is given as common rail. The fuel is transferred through a rigid pipes to each of the fuel injectors, which injects the correct amount of fuel into the combustion chamber. The injectors are operated either mechanically or electronically. At present days ~~electronic~~ electronically controlled system commonly used.

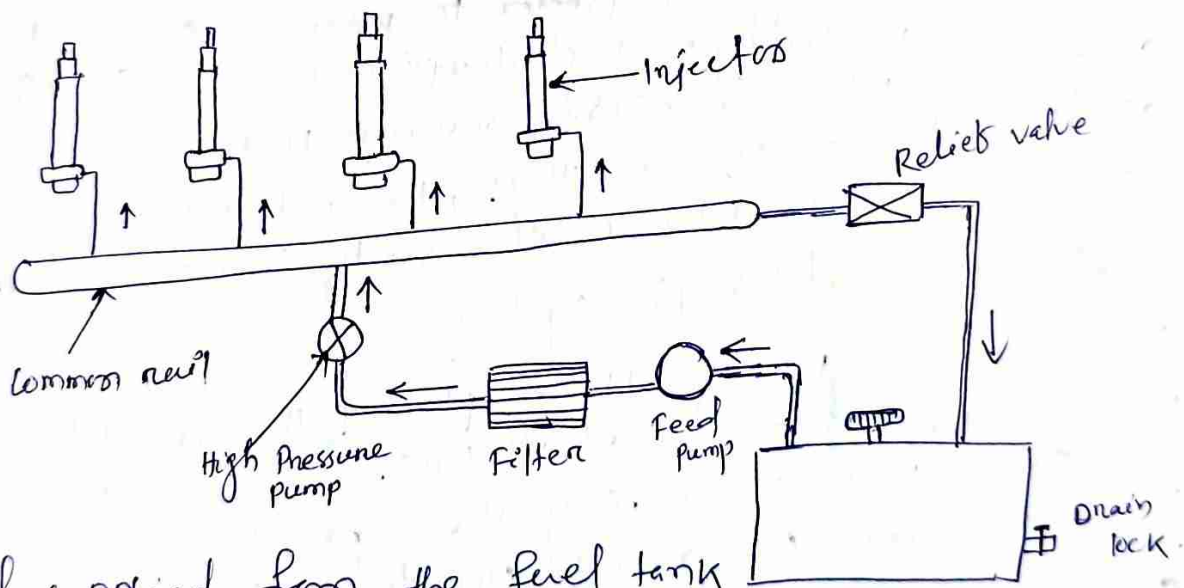

The fuel supplied from the fuel tank by the feed pump. Then it is supplied at low pressure through a filter to high pressure pump. The high pressure pump then supplies the high pressure fuel to the common rail. The common rail is connected to the injectors. And the excess fuel returned to the fuel tank through the relief valve.

Advantages

- ① only one pump is sufficient for multicylinder engines
- ② the injection pressure is produced and governed relatively independent of the engine speed.
- ③ The fuel efficiency and emission is much better due to greater burning of fuel.
- ④ The noise and vibration levels are considerably lower.
- ⑤ Engine operation is very smooth.

Individual pump fuel injection

In this system an inline injection pump is used for pump the injection fuel. The in-line pump is mounted on the side of the engine and has separate pumping unit for each cylinder. The inline pump provides the high pressure for fuel and meters the proper amount of fuel to each cylinder in each injectors.

